

Name: _____

CVCe Words

Directions: Cut and paste the letters to spell the word.

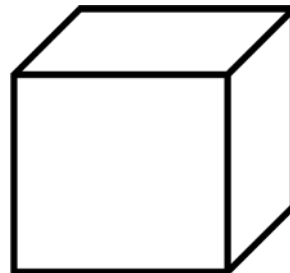

--	--	--	--

--	--	--	--

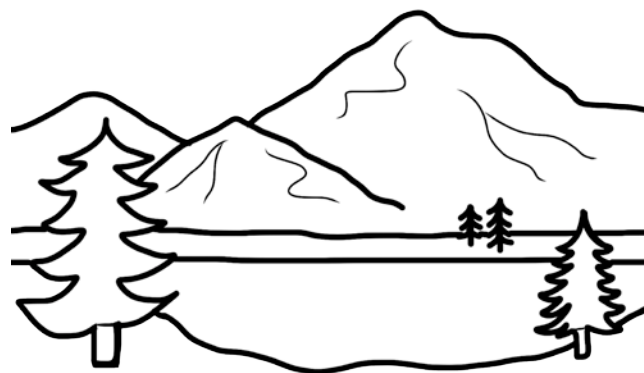
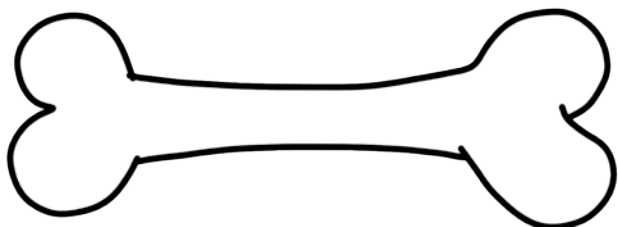

--	--	--	--

--	--	--	--

©www.freewordwork.com

d i m e c u b e

b o n e l a k e

Name: _____

CVCe Words

Directions: Cut and paste the letters to spell the word.



--	--	--	--

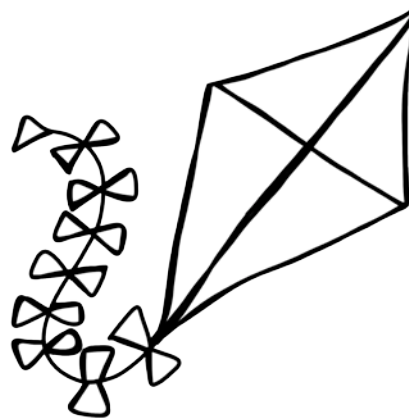

--	--	--	--

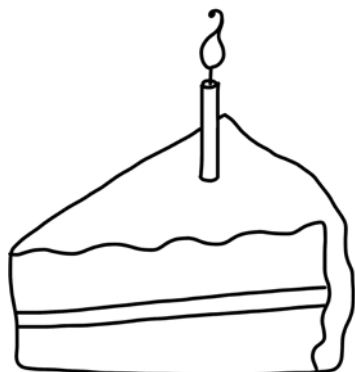

--	--	--	--

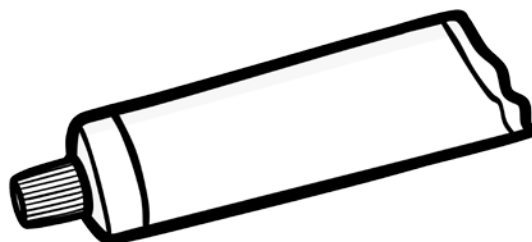

--	--	--	--

©www.freewordwork.com

r	o	b	e	k	i	t	e
c	a	k	e	t	u	b	e

Name: _____

CVCe Words

Directions: Cut and paste the letters to spell the word.

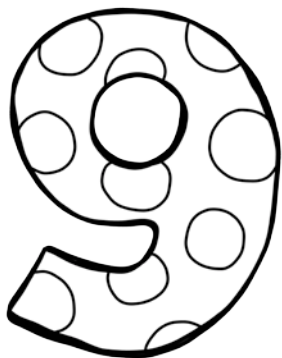
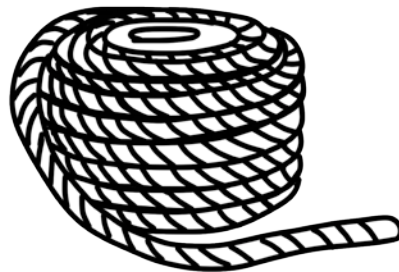
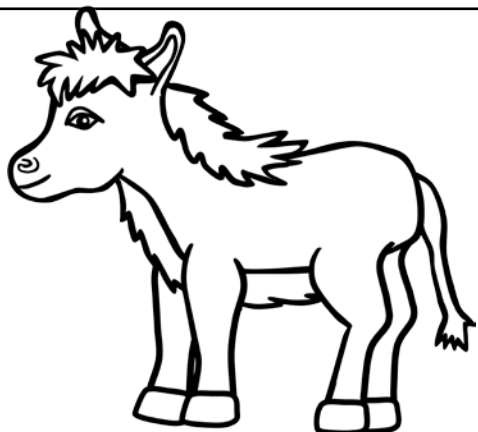

©www.freewordwork.com

m u l e r o p e

n i n e g a m e

Name: _____

CVCe Words

Directions: Cut and paste the letters to spell the word.

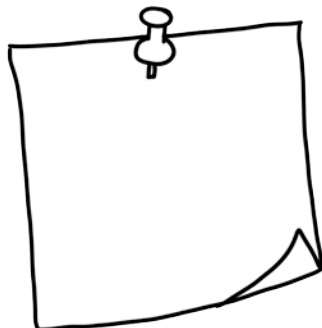

--	--	--	--

--	--	--	--

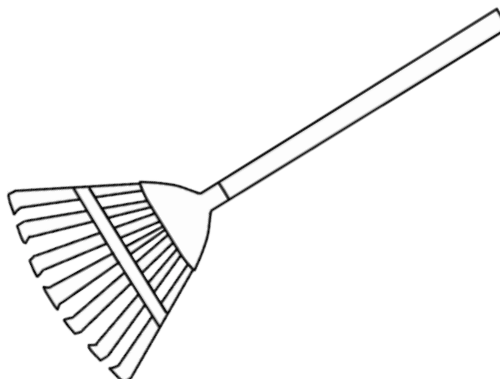
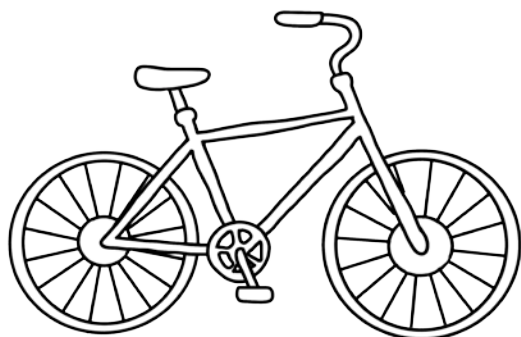

--	--	--	--

--	--	--	--

©www.freewordwork.com

n o t e t u n e

b i k e r a k e

Name: _____

CVCe Words

Directions: Cut and paste the letters to spell the word.

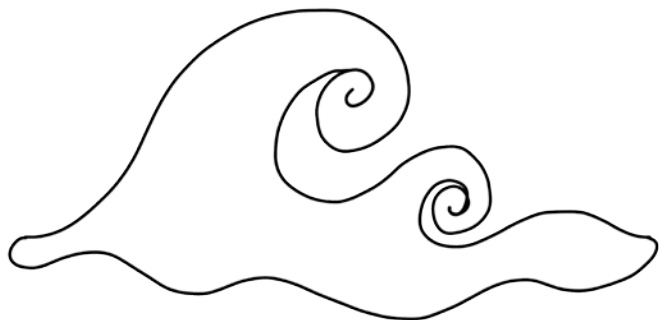

--	--	--	--

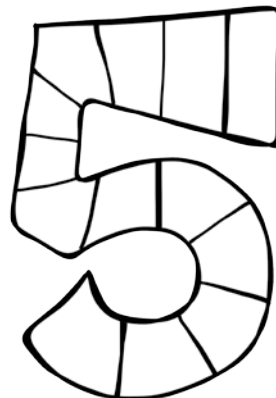

--	--	--	--



--	--	--	--



--	--	--	--

©www.freewordwork.com

w	a	v	e	f	i	v	e
r	o	s	e	b	a	k	e

Name: _____

CVCe Words

Directions: Cut and paste the letters to spell the word.



--	--	--	--

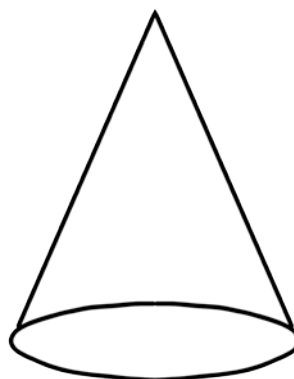

--	--	--	--

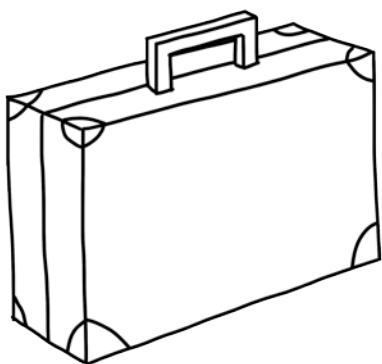

--	--	--	--

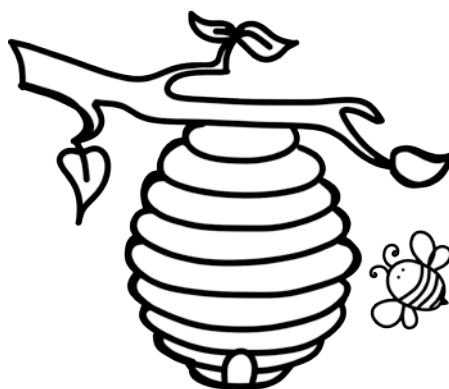

--	--	--	--

©www.freewordwork.com

v i n e c o n e

c a s e h i v e

Name: _____

CVCe Words

Directions: Cut and paste the letters to spell the word.

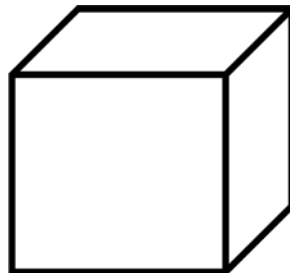

--	--	--	--

--	--	--	--

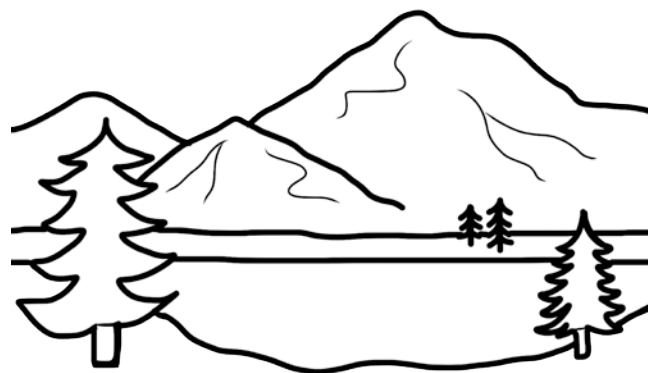
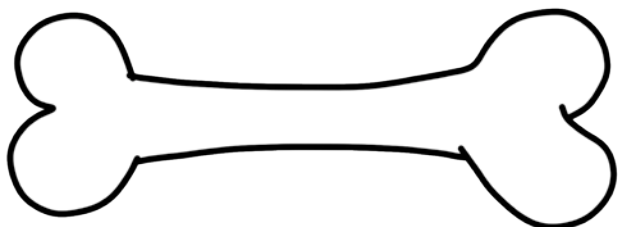

--	--	--	--

--	--	--	--

©www.freewordwork.com

e	e	e	e	i	o	u	a
b	b	c	d	k	l	m	n

Name: _____

CVCe Words

Directions: Cut and paste the letters to spell the word.



--	--	--	--

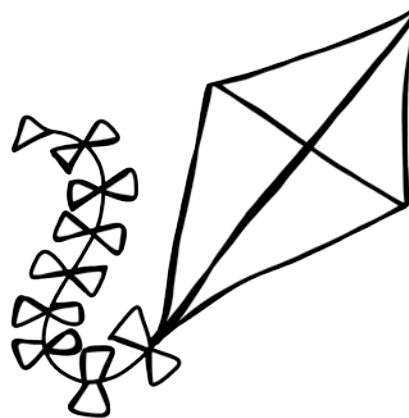

--	--	--	--

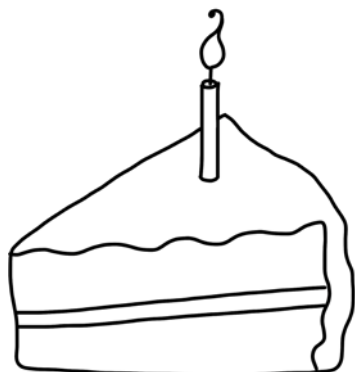

--	--	--	--

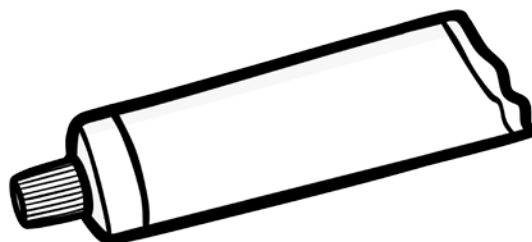

--	--	--	--

©www.freewordwork.com

e	e	e	e	a	i	o	u
b	b	c	k	k	r	t	t

Name: _____

CVCe Words

Directions: Cut and paste the letters to spell the word.

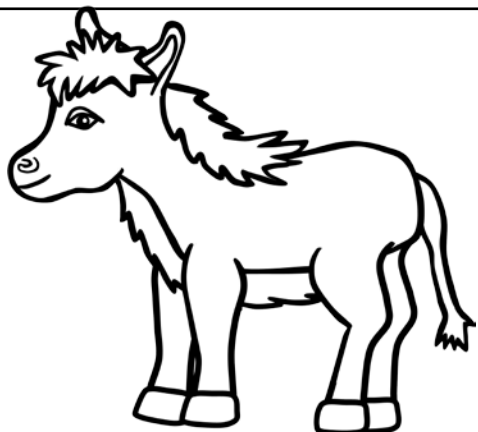

--	--	--	--

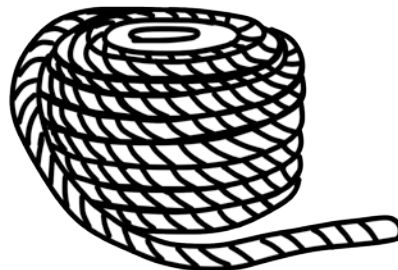

--	--	--	--

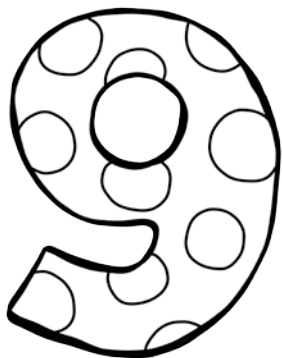

--	--	--	--



--	--	--	--

©www.freewordwork.com

e

e

e

e

a

i

o

u

g

l

m

m

n

n

p

r

Name: _____

CVCe Words

Directions: Cut and paste the letters to spell the word.

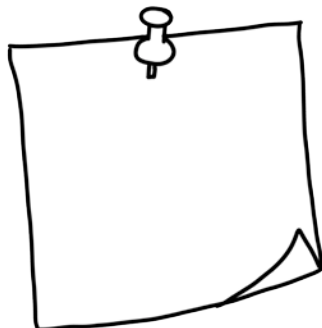

--	--	--	--

--	--	--	--

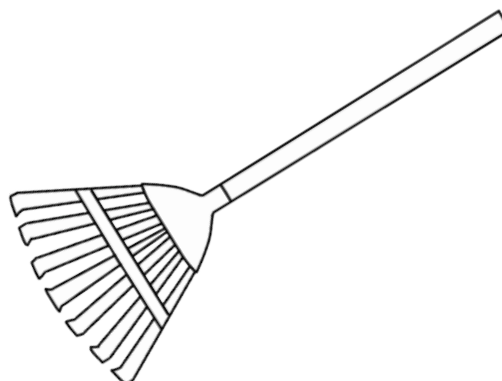
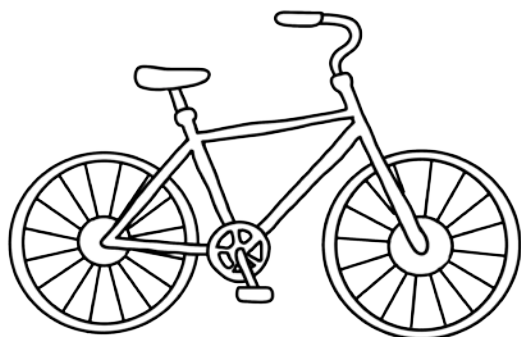

--	--	--	--

--	--	--	--

©www.freewordwork.com

e

e

e

e

a

i

o

u

b

k

k

n

n

r

t

t

Name: _____

CVCe Words

Directions: Cut and paste the letters to spell the word.

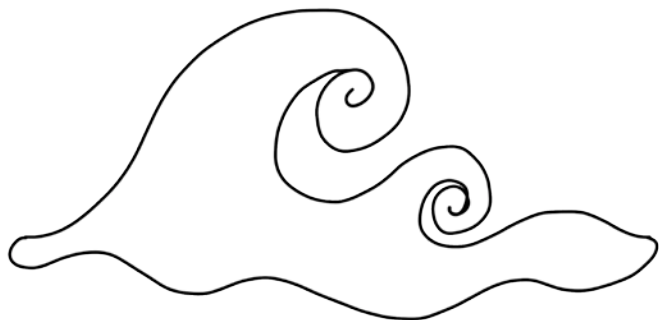

--	--	--	--

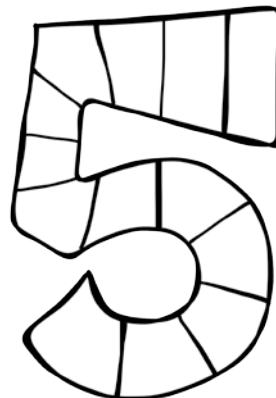

--	--	--	--



--	--	--	--



--	--	--	--

©www.freewordwork.com

w	a	v	e	f	i	v	e
r	o	s	e	b	a	k	e

Name: _____

CVCe Words

Directions: Cut and paste the letters to spell the word.

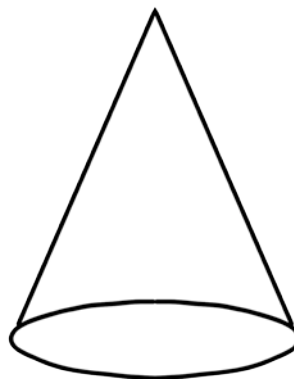

--	--	--	--

--	--	--	--

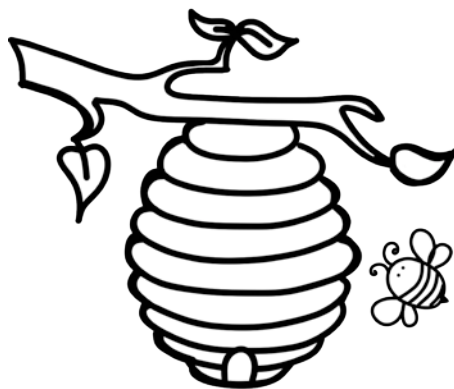
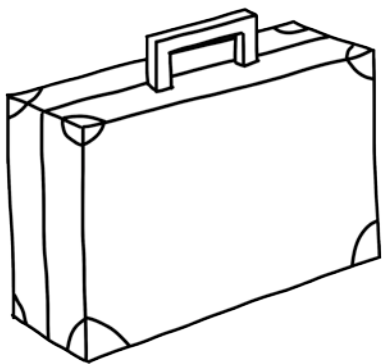

--	--	--	--

--	--	--	--

©www.freewordwork.com

e	e	e	e	a	i	i	o
c	c	h	n	n	s	v	v

Name: _____

CVCe Words

Directions: Cut and paste the vowels to spell the words.

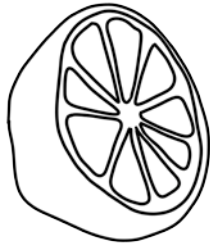

l		m	e
---	--	---	---

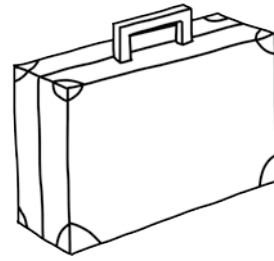

c		s	e
---	--	---	---



r		b	e
---	--	---	---

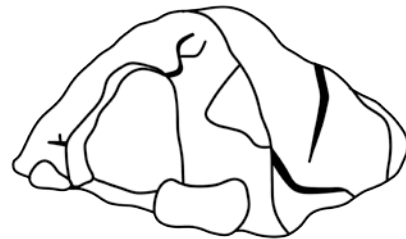

c		v	e
---	--	---	---



t		n	e
---	--	---	---

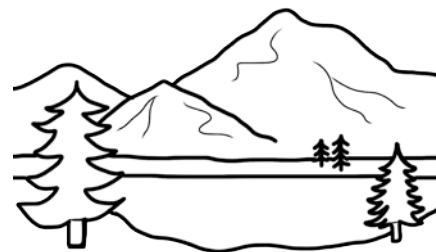

l		k	e
---	--	---	---

©www.freewordwork.com

a	o	i	u	a	a
---	---	---	---	---	---

Name: _____

CVCe Words

Directions: Cut and paste the vowels to spell the words.



c

k

e



d

m

e

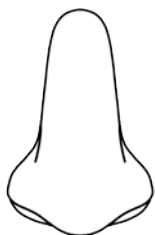

n

s

e

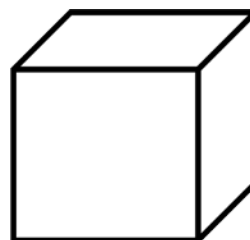

c

b

e



t

m

e

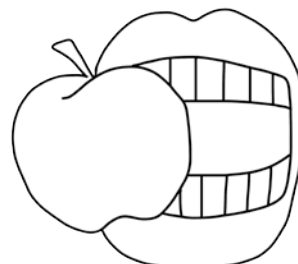

b

t

e

©www.freewordwork.com

u

i

i

a

i

o

Name: _____

CVCe Words

Directions: Cut and paste the vowels to spell the words.

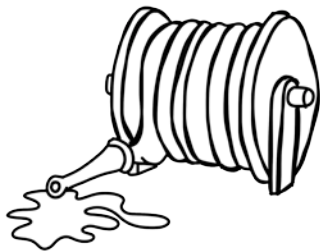

c

k

e

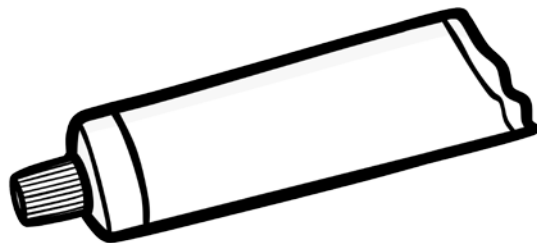

d

m

e



n

s

e



c

b

e



t

m

e



b

t

e

©www.freewordwork.com

a

a

i

o

u

i

Name: _____

CVCe Words

Directions: Cut and paste the vowels to spell the words.



m

l

e



g

m

e

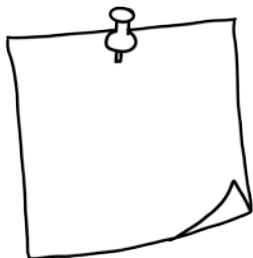

n

t

e

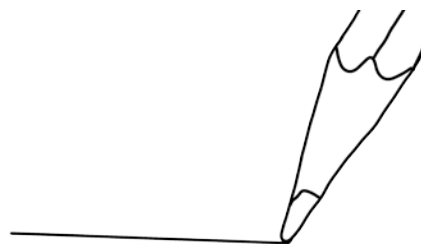

l

n

e



h

v

e

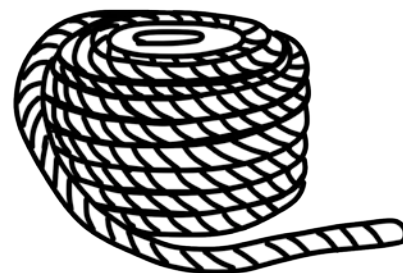

r

p

e

©www.freewordwork.com

a

o

u

i

i

o

Name: _____

CVCe Words

Directions: Cut and paste the picture for each word.

bite

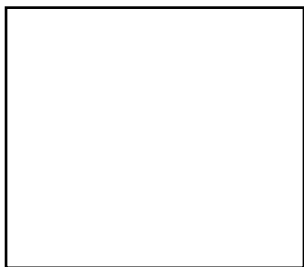

game

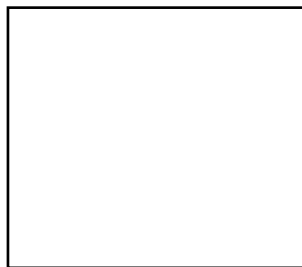

time

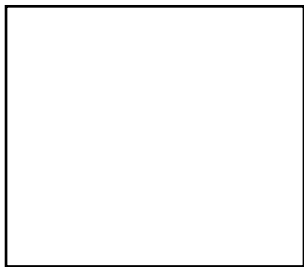

mule

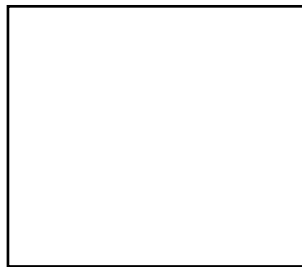

home

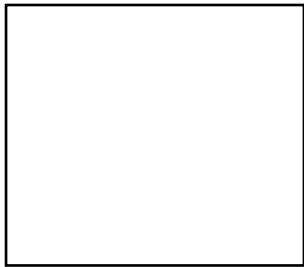

hive

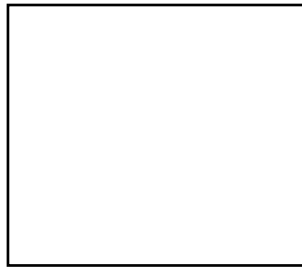

©www.freewordwork.com



Name: _____

CVCe Words

Directions: Cut and paste the picture for each word.

lime

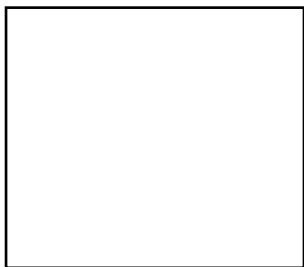

cave

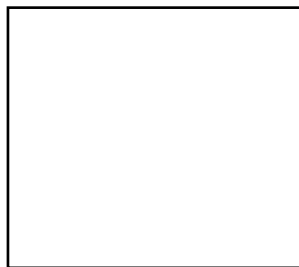

cube

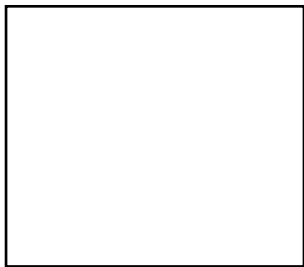

hose

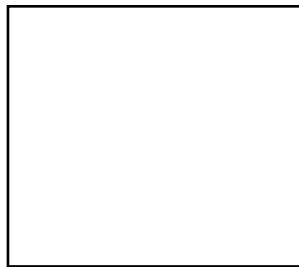

kite

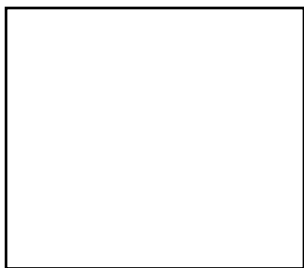

cake

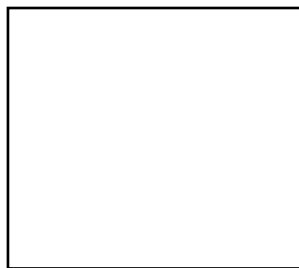

©www.freewordwork.com

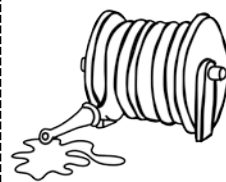
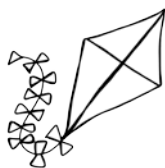
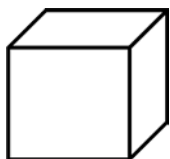
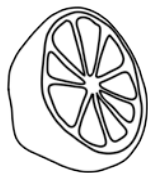

Name: _____

CVCe Words

Directions: Cut and paste the picture for each word.

date

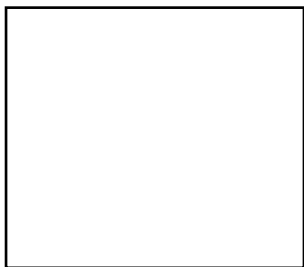

bike

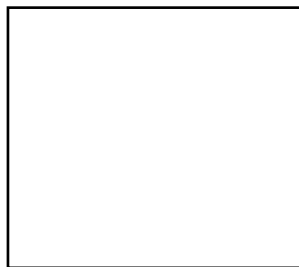

rope

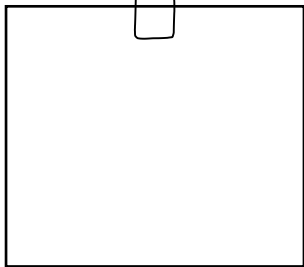

case

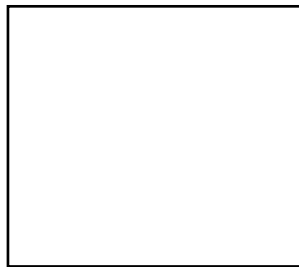

dime

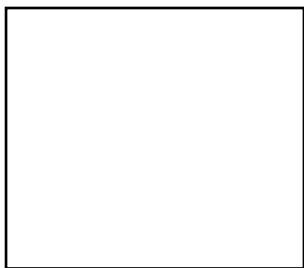

nose

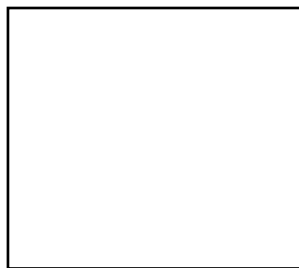

©www.freewordwork.com

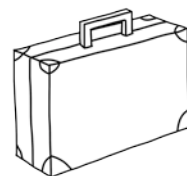
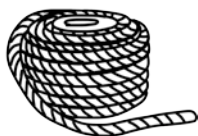

Name: _____

CVCe Words

Directions: Cut and paste the picture for each word.

rake

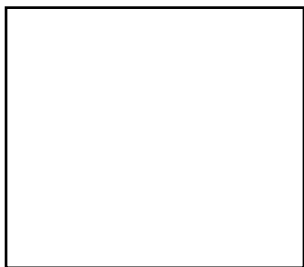

nine

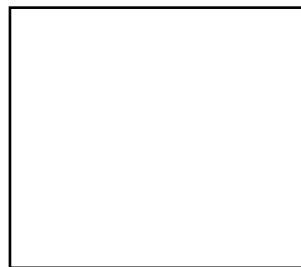

tune

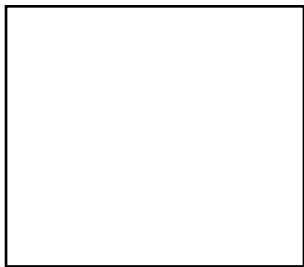

cone

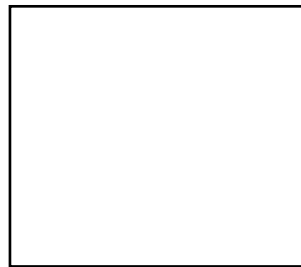

lake

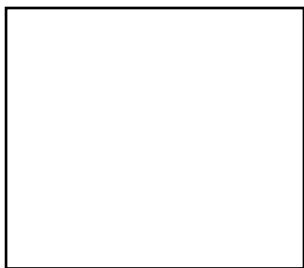

name

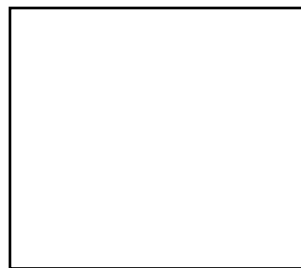

©www.freewordwork.com

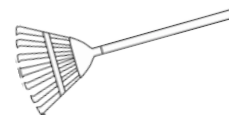

Name: _____

CVCe Words

Directions: Cut and paste the picture for each word.

five

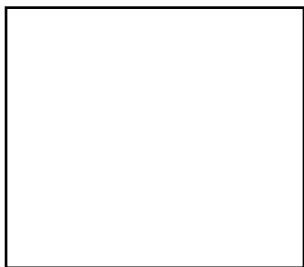

bone

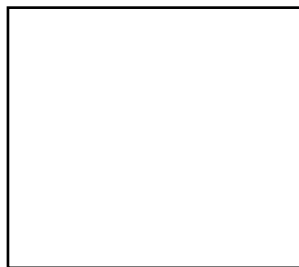

tube

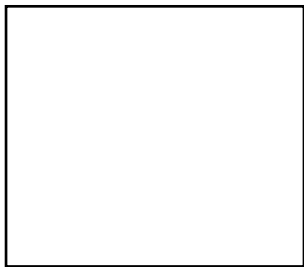

bake

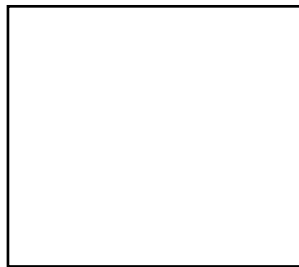

wave

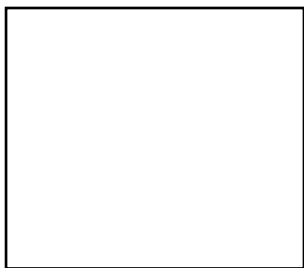

line

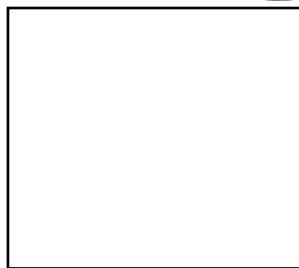

©www.freewordwork.com



Name: _____

Directions: Unscramble the letters. Write the word in the word boxes. Cut and paste the picture.

ieln

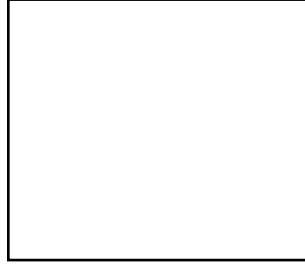
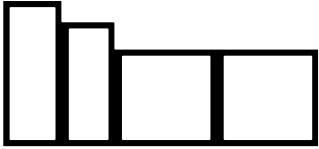

ienn

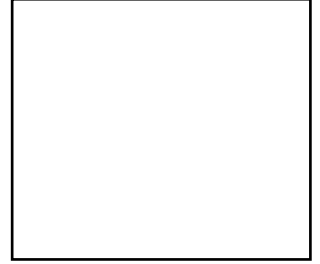

dewv



oecn

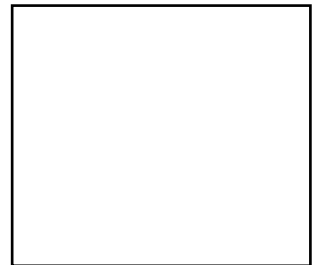

aedt

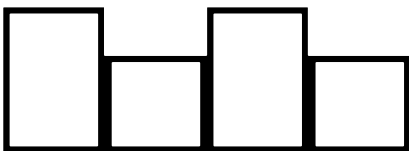

ienv

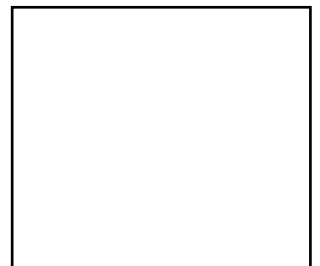

Name: _____

Directions: Unscramble the letters. Write the word in the word boxes. Cut and paste the picture.

uelm

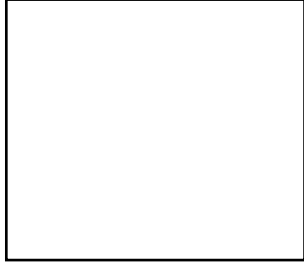
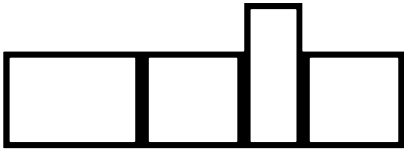

iedm

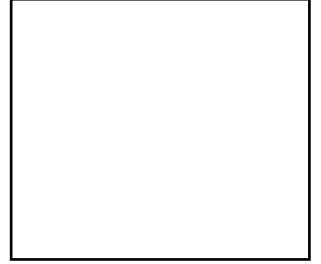
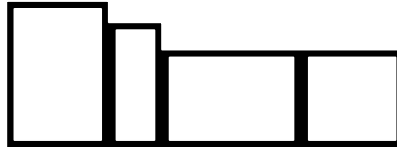

oehs

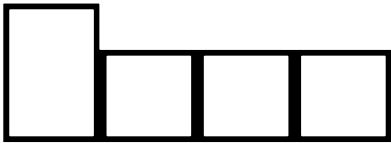

aecs

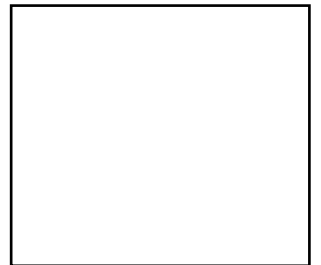

aecv

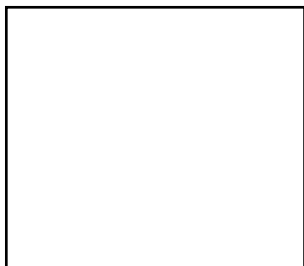

aebk

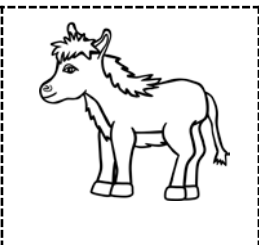
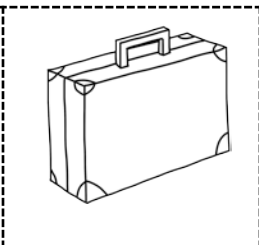
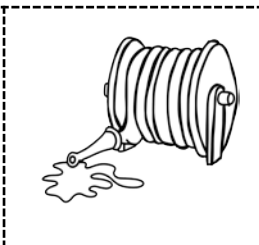
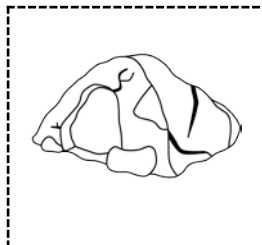
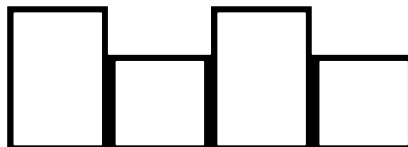

Name: _____

Directions: Unscramble the letters. Write the word in the word boxes. Cut and paste the picture.

iebk

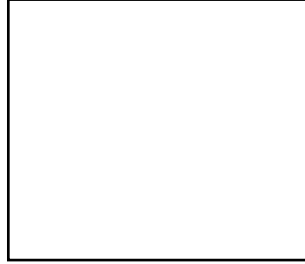
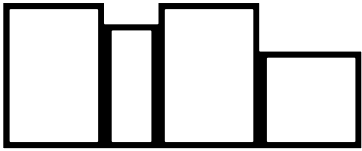

aegm

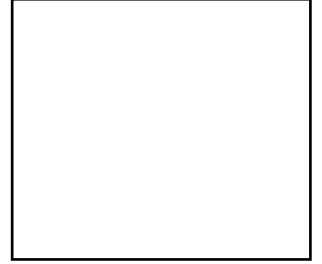
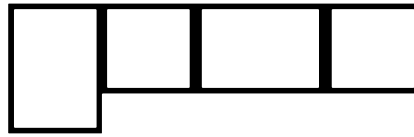

oebn

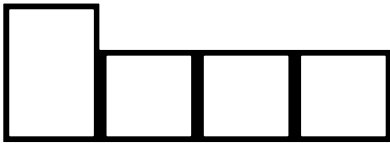

uebt

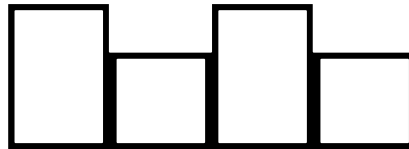

iemt

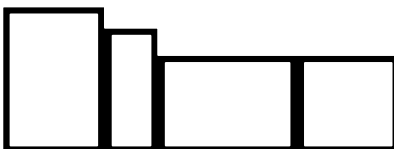

oent

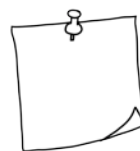
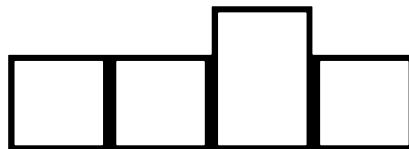

Name: _____

Directions: Unscramble the letters. Write the word in the word boxes. Cut and paste the picture.

aeck

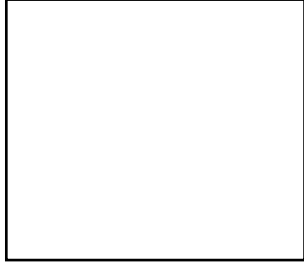
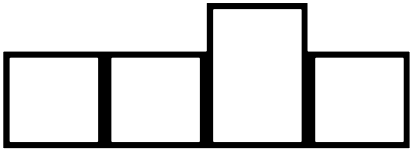

aekl

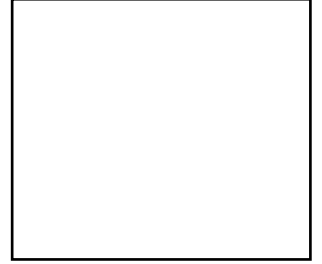
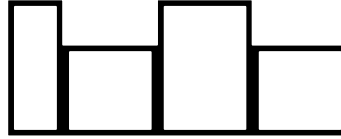

iebt



ielm

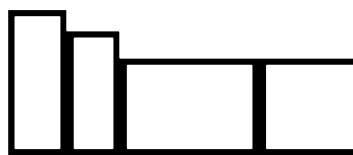

iehv

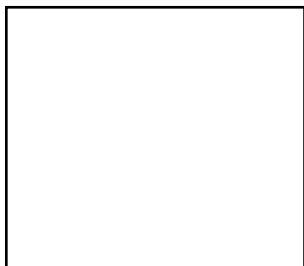

oens

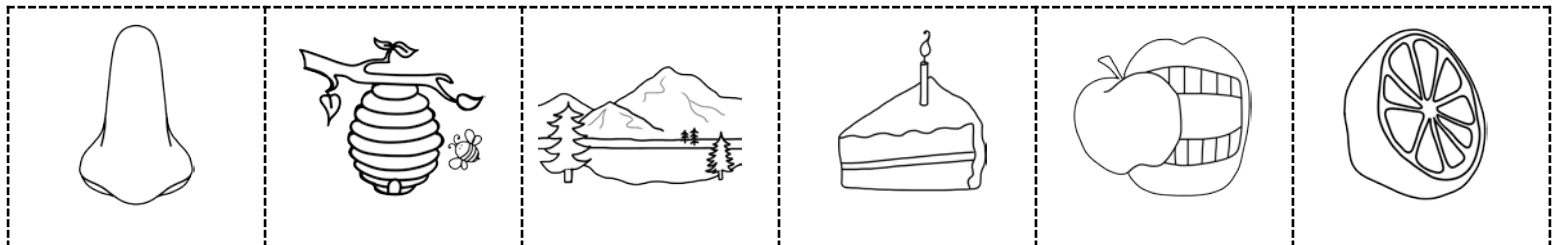
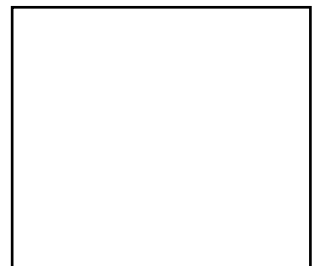

Name: _____

Directions: Unscramble the letters. Write the word in the word boxes. Cut and paste the picture.

iekt

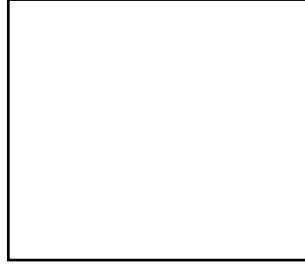
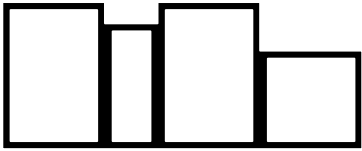

aekr

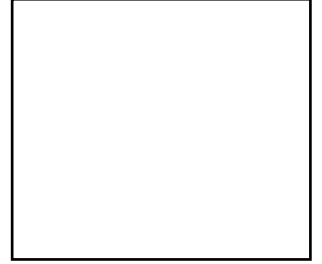
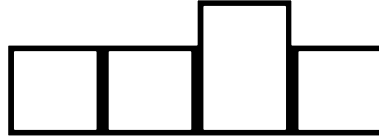

aemn

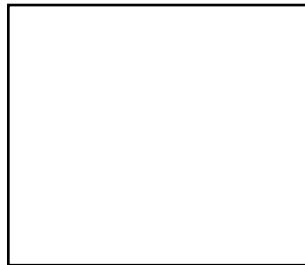

oers



uebc

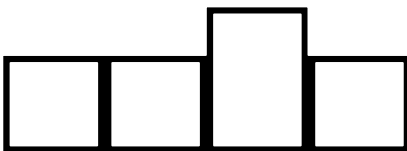

iefv

