

Name: _____

CVC Words

Hidden Pictures

Directions: How many can you find?

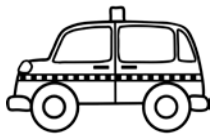
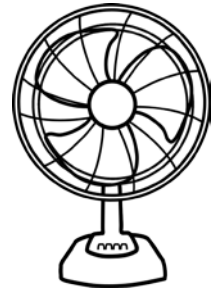
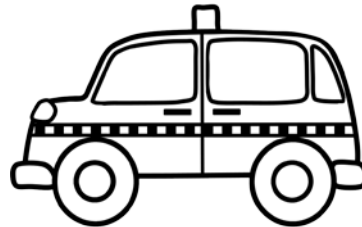
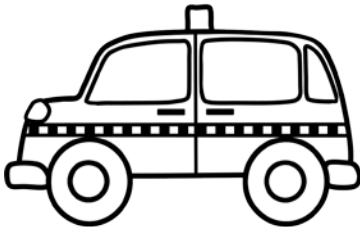
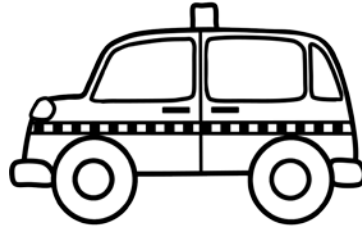
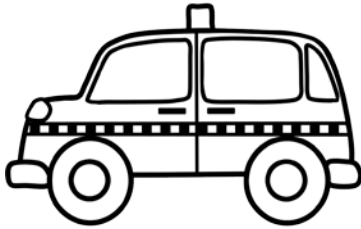
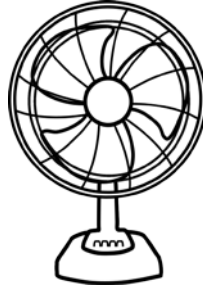

How many do you see?

Write the word.

cab

bag

fan

sad





Name: _____

CVC Words

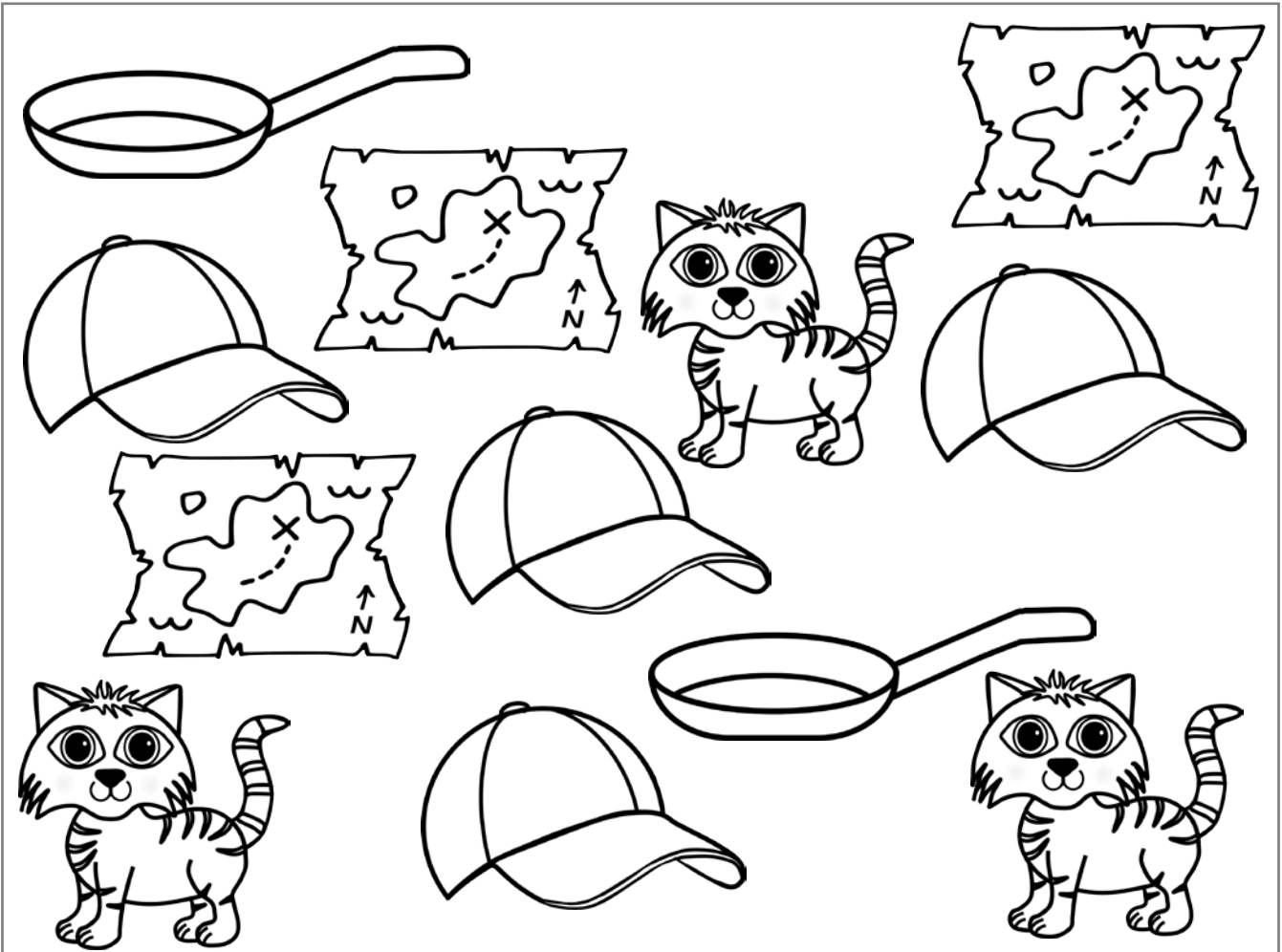
Hidden Pictures

Directions: How many can you find?



				
How many do you see?				
Write the word.	<u> </u> cat <u> </u>	<u> </u> map <u> </u>	<u> </u> pan <u> </u>	<u> </u> cap <u> </u>



Name: _____

CVC Words

Hidden Pictures

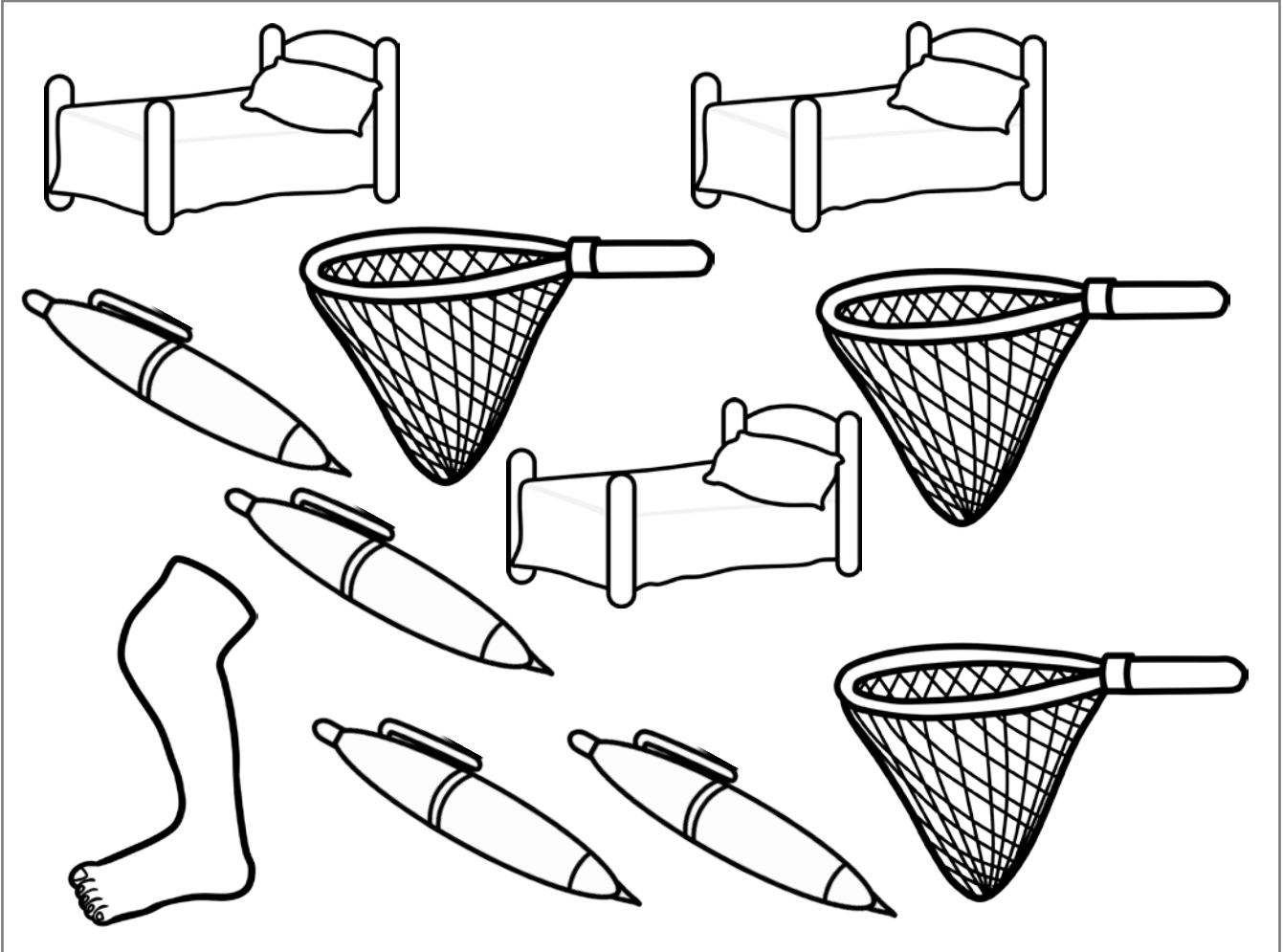
Directions: How many can you find?

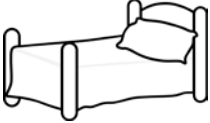
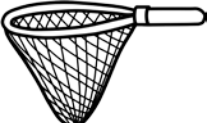

				
How many do you see?				
Write the word.	<u> </u> bed <u> </u>	<u> </u> net <u> </u>	<u> </u> pen <u> </u>	<u> </u> leg <u> </u>





Name: _____

CVC Words

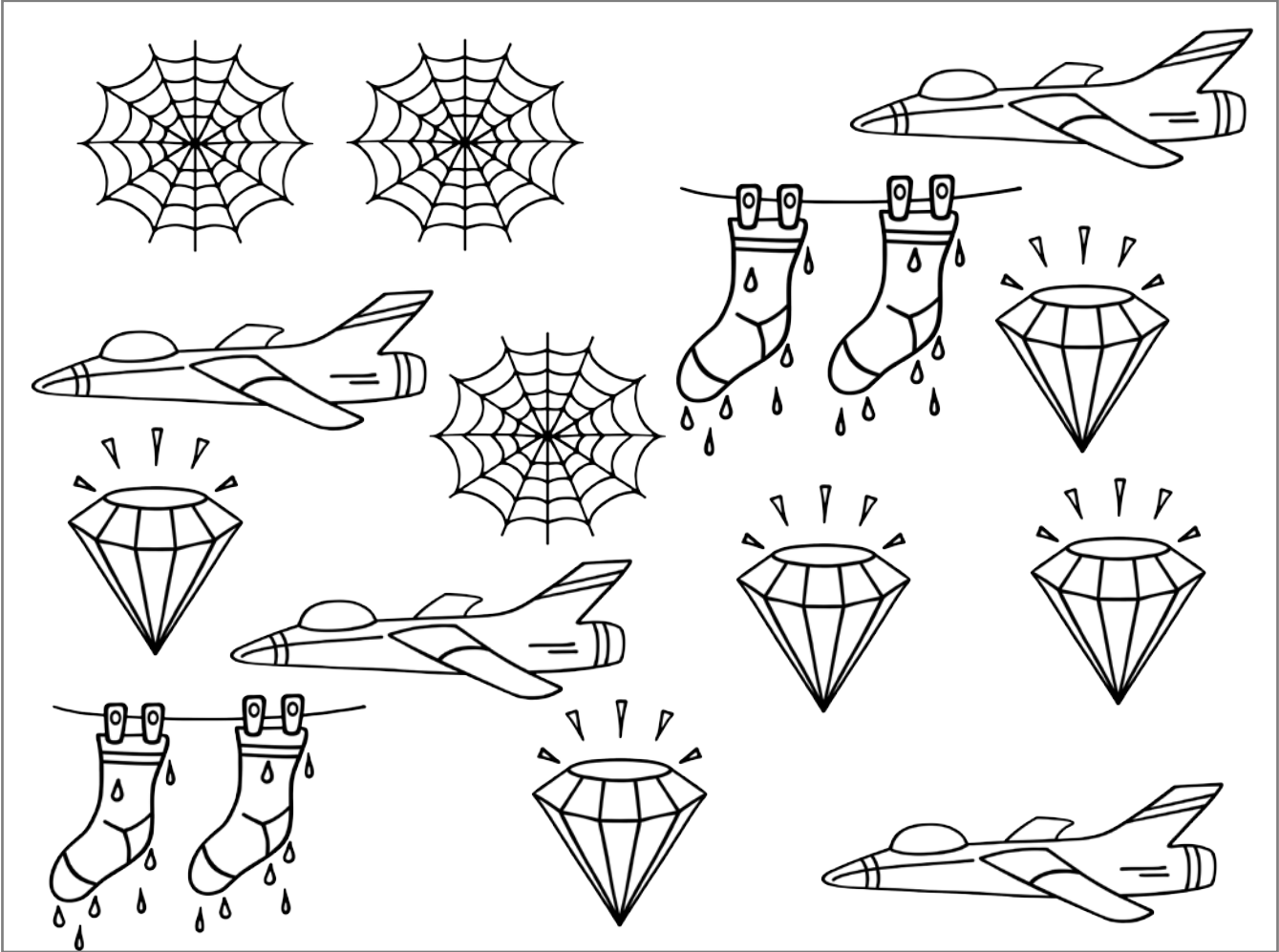
Hidden Pictures

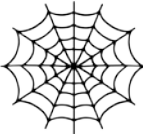
Directions: How many can you find?



				
How many do you see?				
Write the word.	<u> </u> web	<u> </u> gem	<u> </u> wet	<u> </u> jet





Name: _____

CVC Words

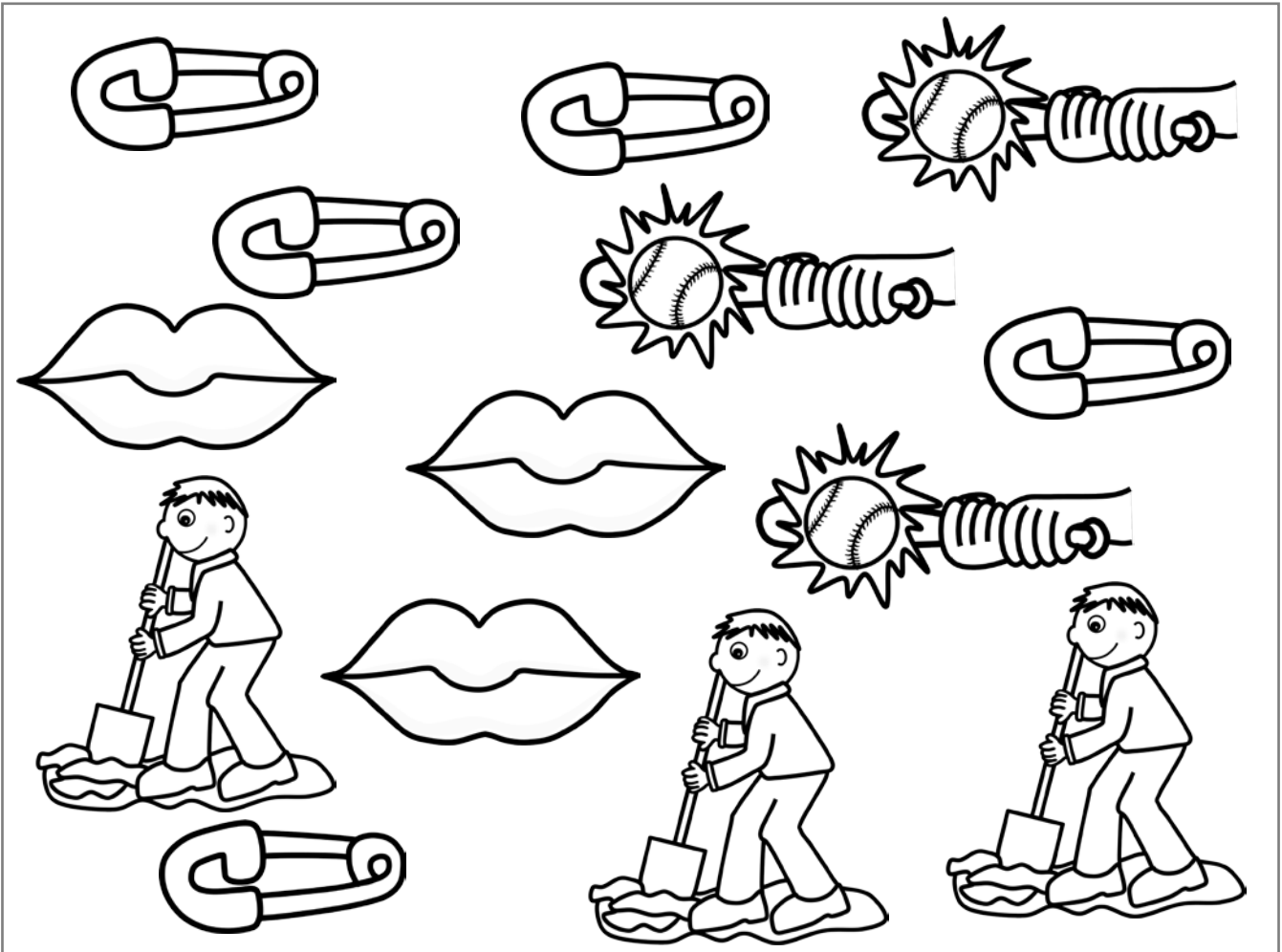
Hidden Pictures

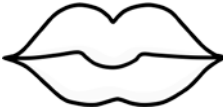
Directions: How many can you find?

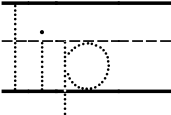
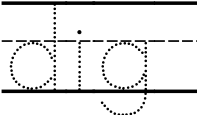
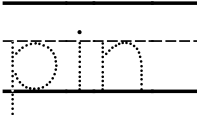
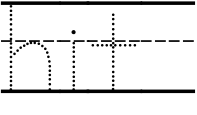

				
How many do you see?				
Write the word.				





Name: _____

CVC Words

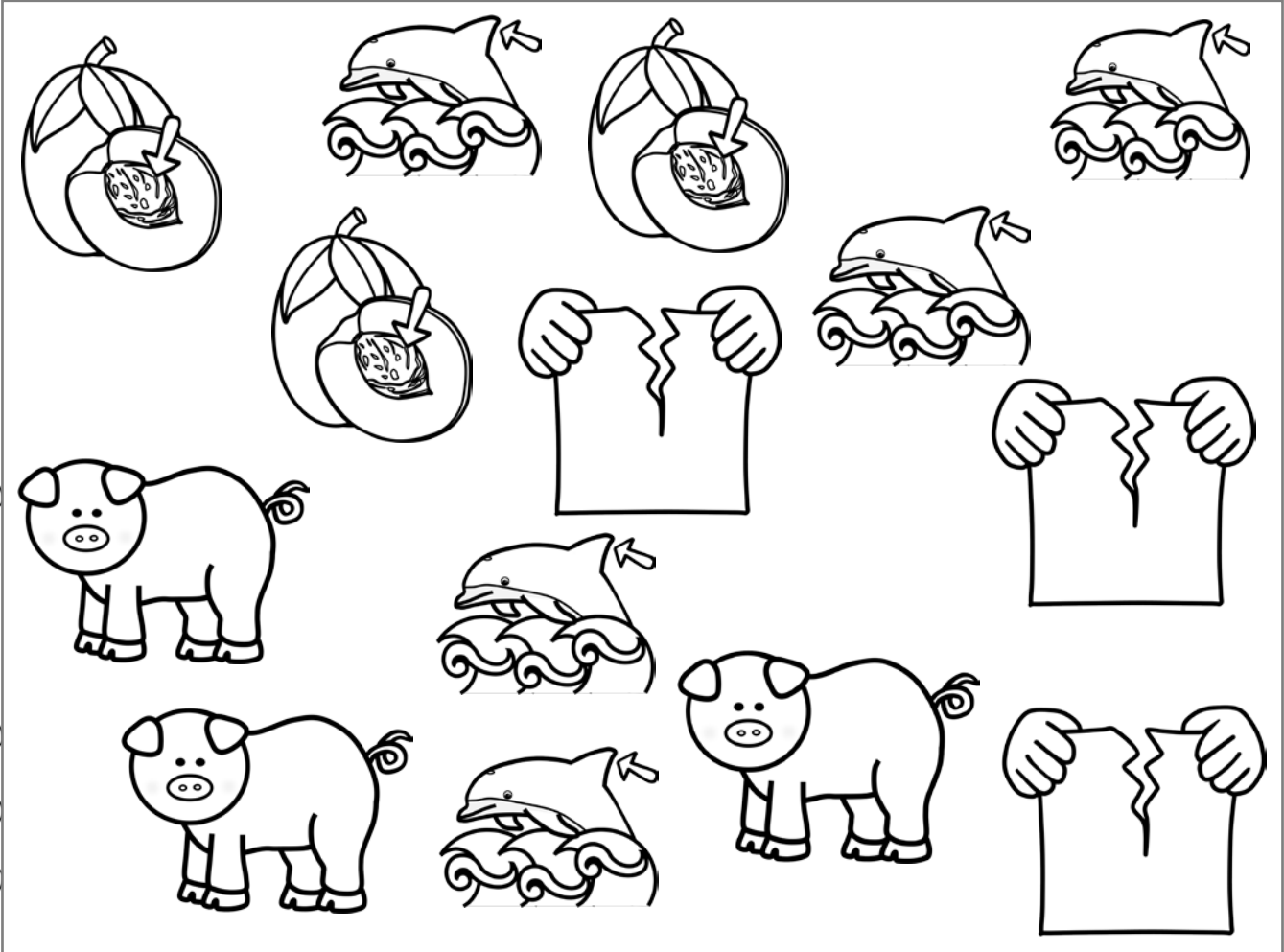
Hidden Pictures

Directions: How many can you find?

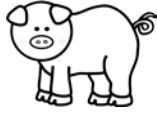

				
How many do you see?				
Write the word.	<u> </u> pit	<u> </u> rip	<u> </u> pig	<u> </u> fin





Name: _____

CVC Words

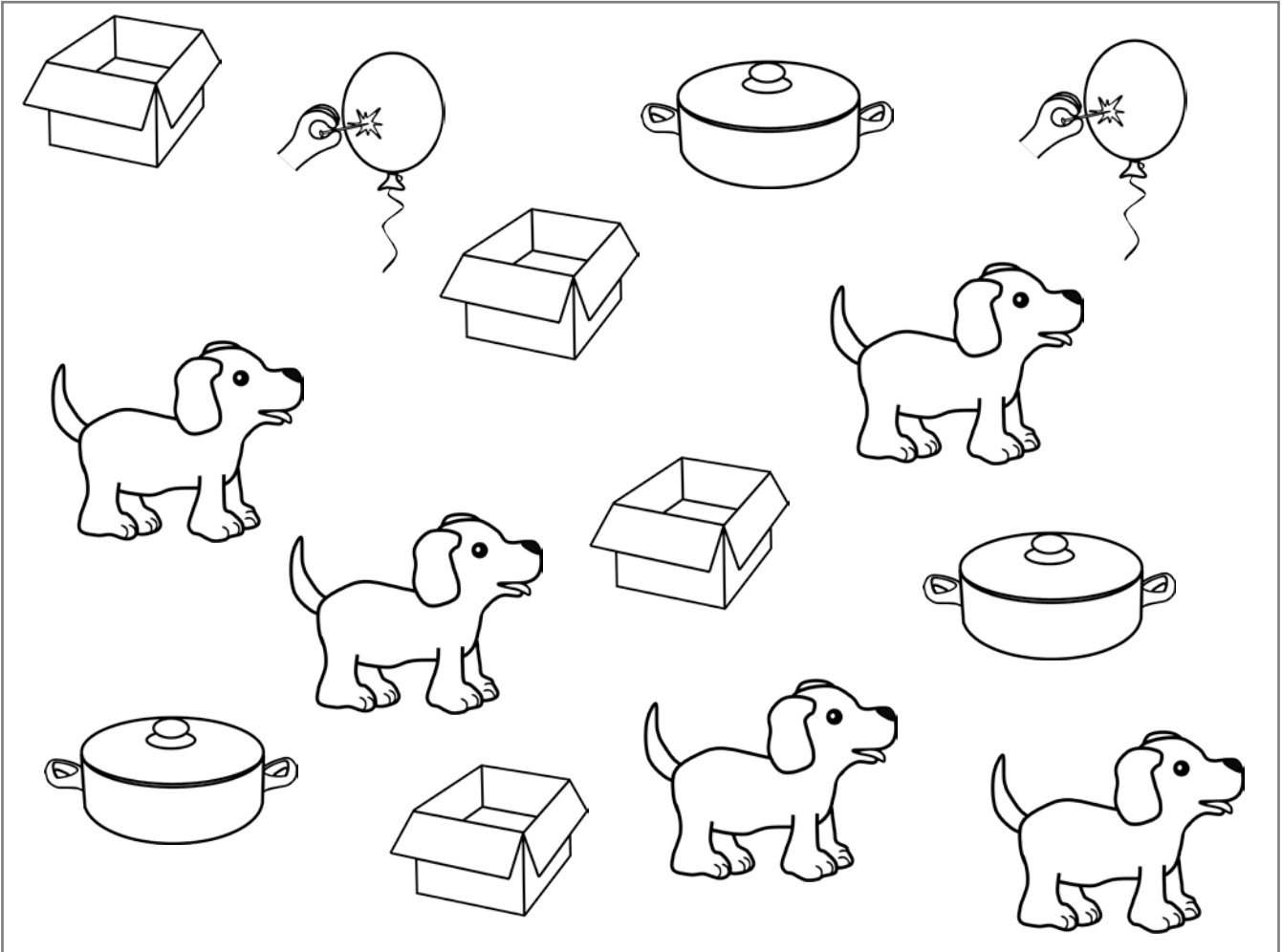
Hidden Pictures

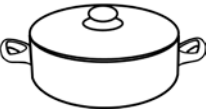
Directions: How many can you find?



				
How many do you see?				
Write the word.	<u> </u> pot <u> </u>	<u> </u> dog <u> </u>	<u> </u> box <u> </u>	<u> </u> pop <u> </u>





Name: _____

CVC Words

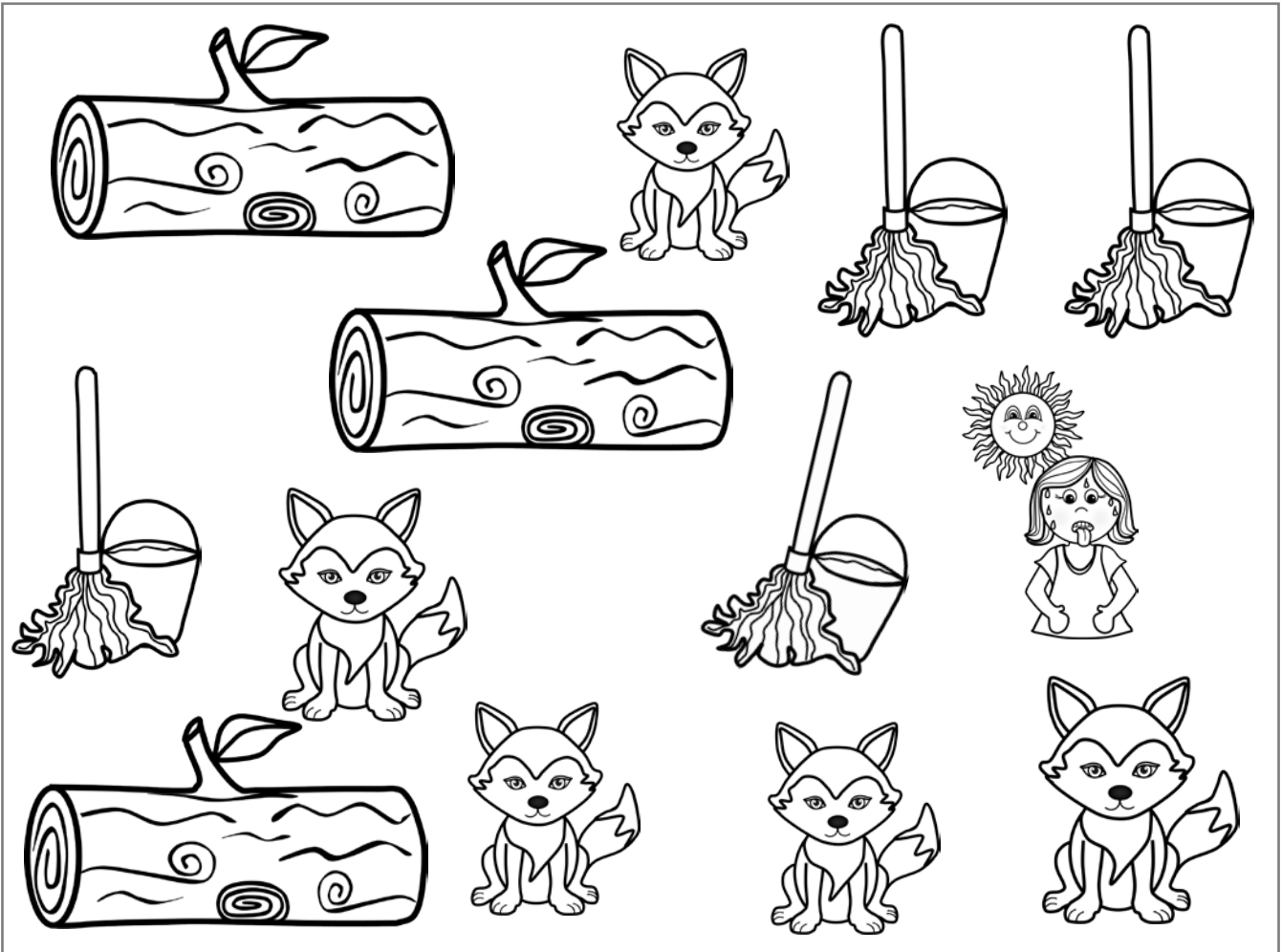
Hidden Pictures

Directions: How many can you find?



				
How many do you see?				
Write the word.	hot	Log	fox	mop





Name: _____

CVC Words

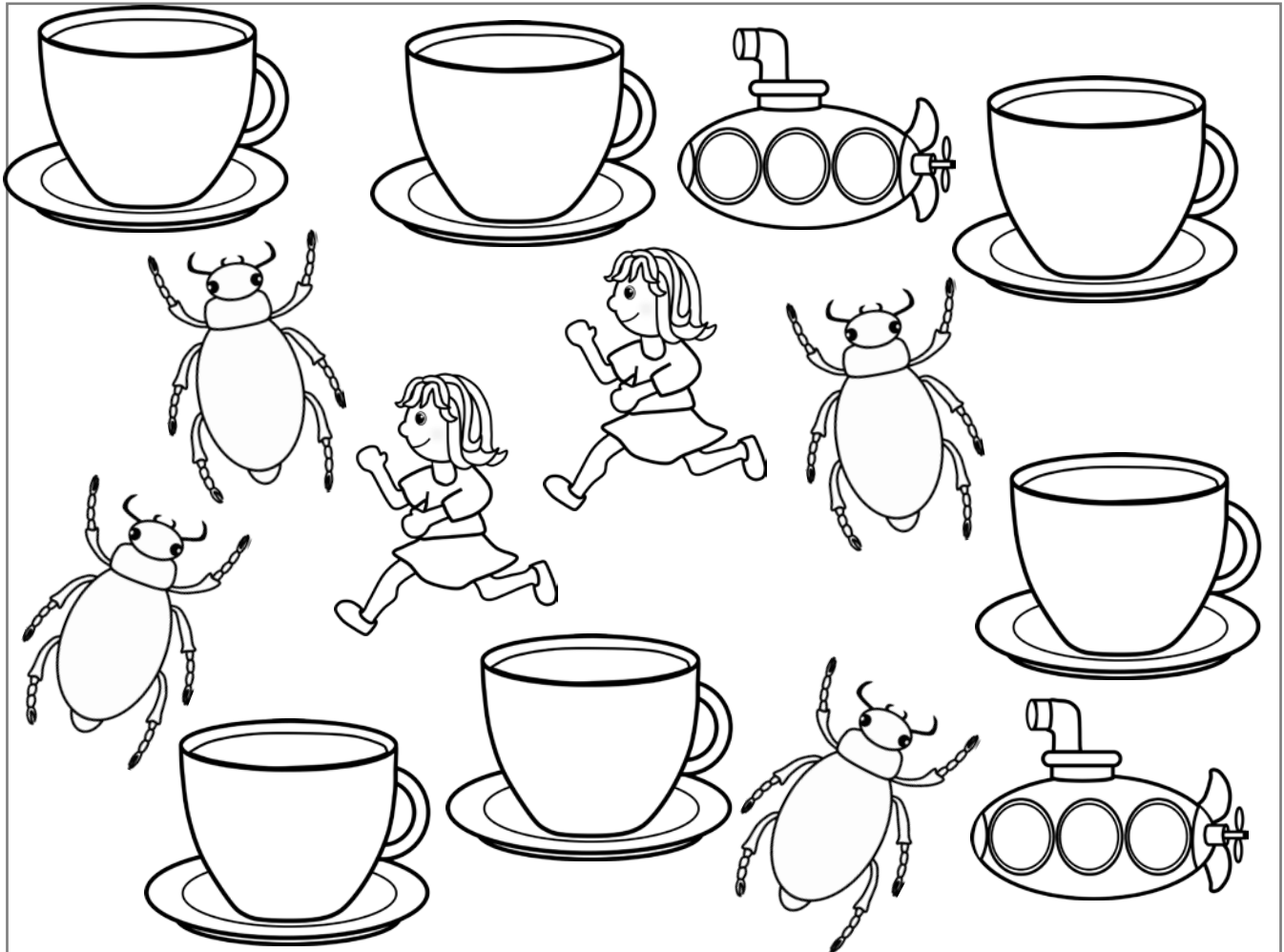
Hidden Pictures

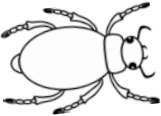
Directions: How many can you find?



				
How many do you see?				
Write the word.	<u> </u> bug <u> </u>	<u> </u> run <u> </u>	<u> </u> cup <u> </u>	<u> </u> sub <u> </u>

Name: _____

CVC Words

Hidden Pictures

Directions: How many can you find?



How many do you see?

Write the word.

sun

nut

tub

hug







Name: _____

CVC Words

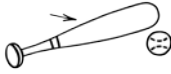
Hidden Pictures

Directions: How many can you find?



				
How many do you see?				
Write the word.	rip	bat	dog	bus
				
How many do you see?				
Write the word.	vet	dig	jam	cut







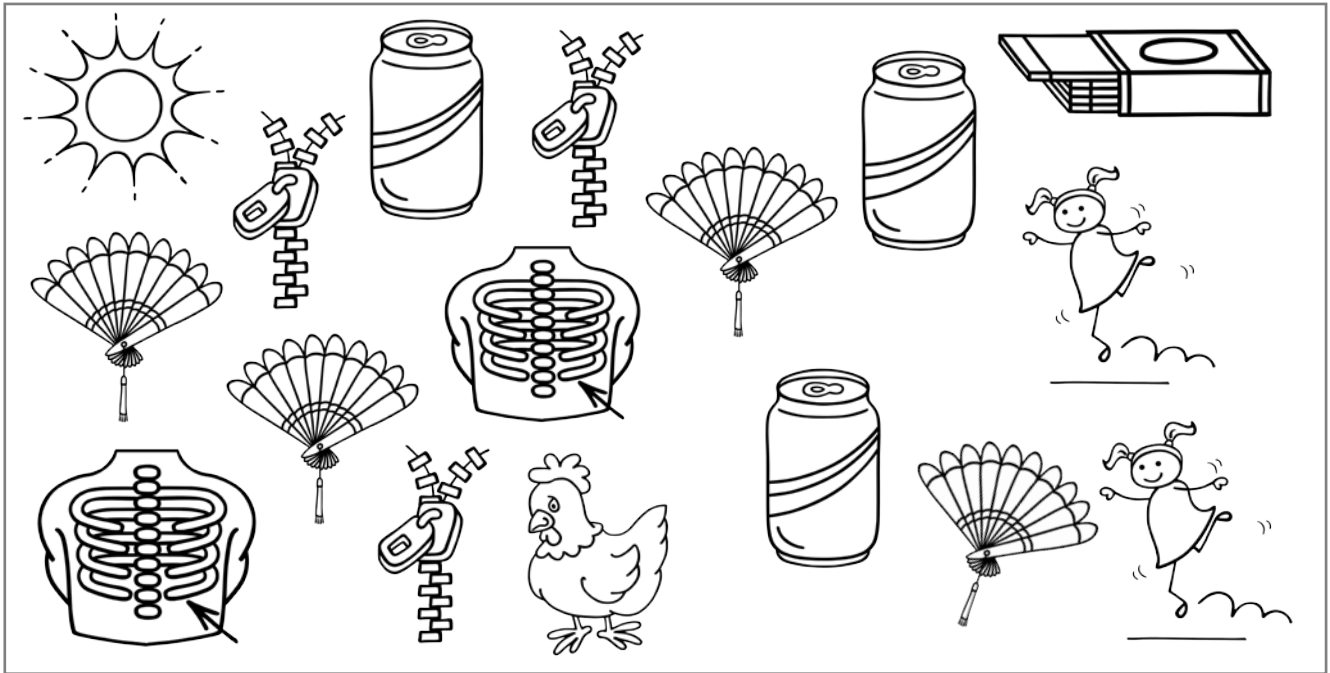

Name: _____

CVC Words

Hidden Pictures

Directions: How many can you find?



				
How many do you see?				
Write the word.	sun	zip	fan	gum
				
How many do you see?				
Write the word.	can	hen	rib	hop

Name: _____

CVC Words

Hidden Pictures

Directions: How many can you find?

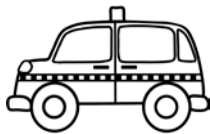
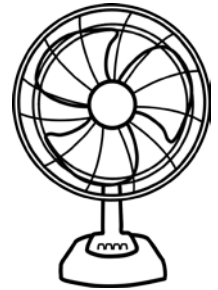
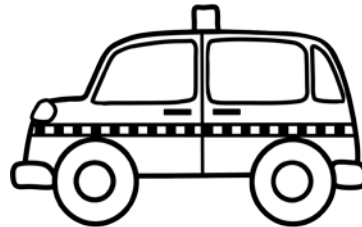
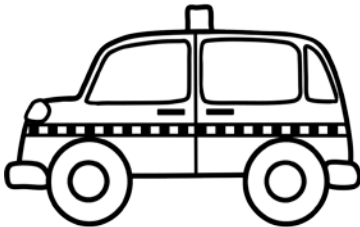
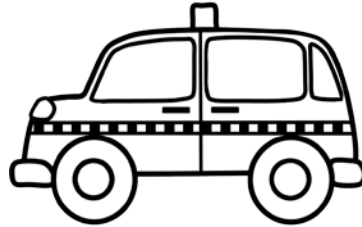
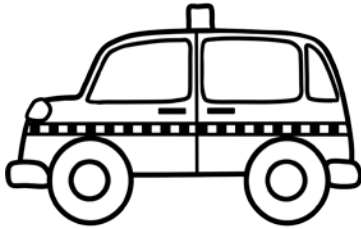
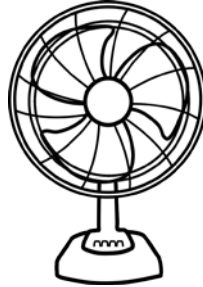

How many do you see?

Write the word.





Name: _____

CVC Words

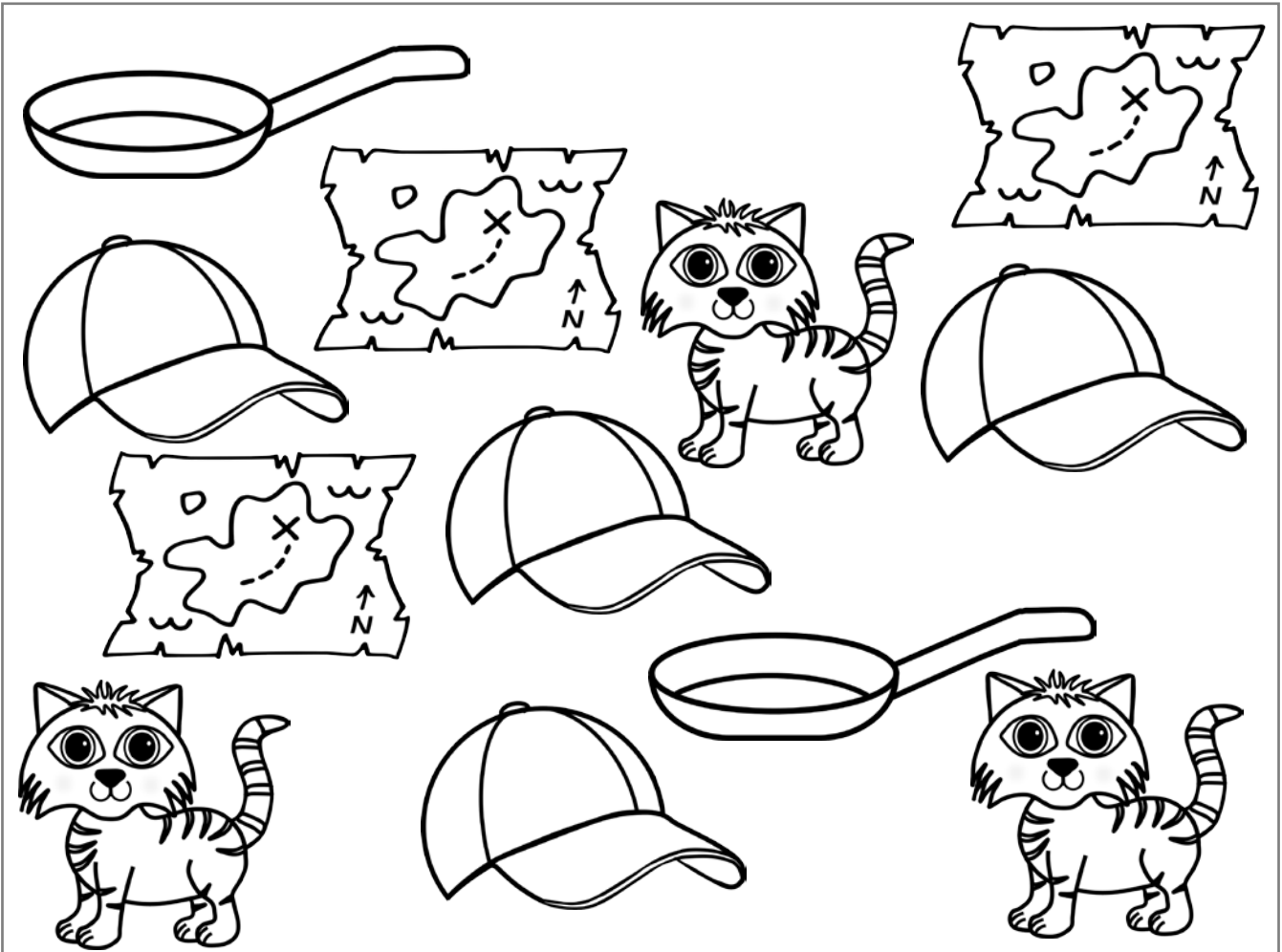
Hidden Pictures

Directions: How many can you find?



				
How many do you see?				
Write the word.				



Name: _____

CVC Words

Hidden Pictures

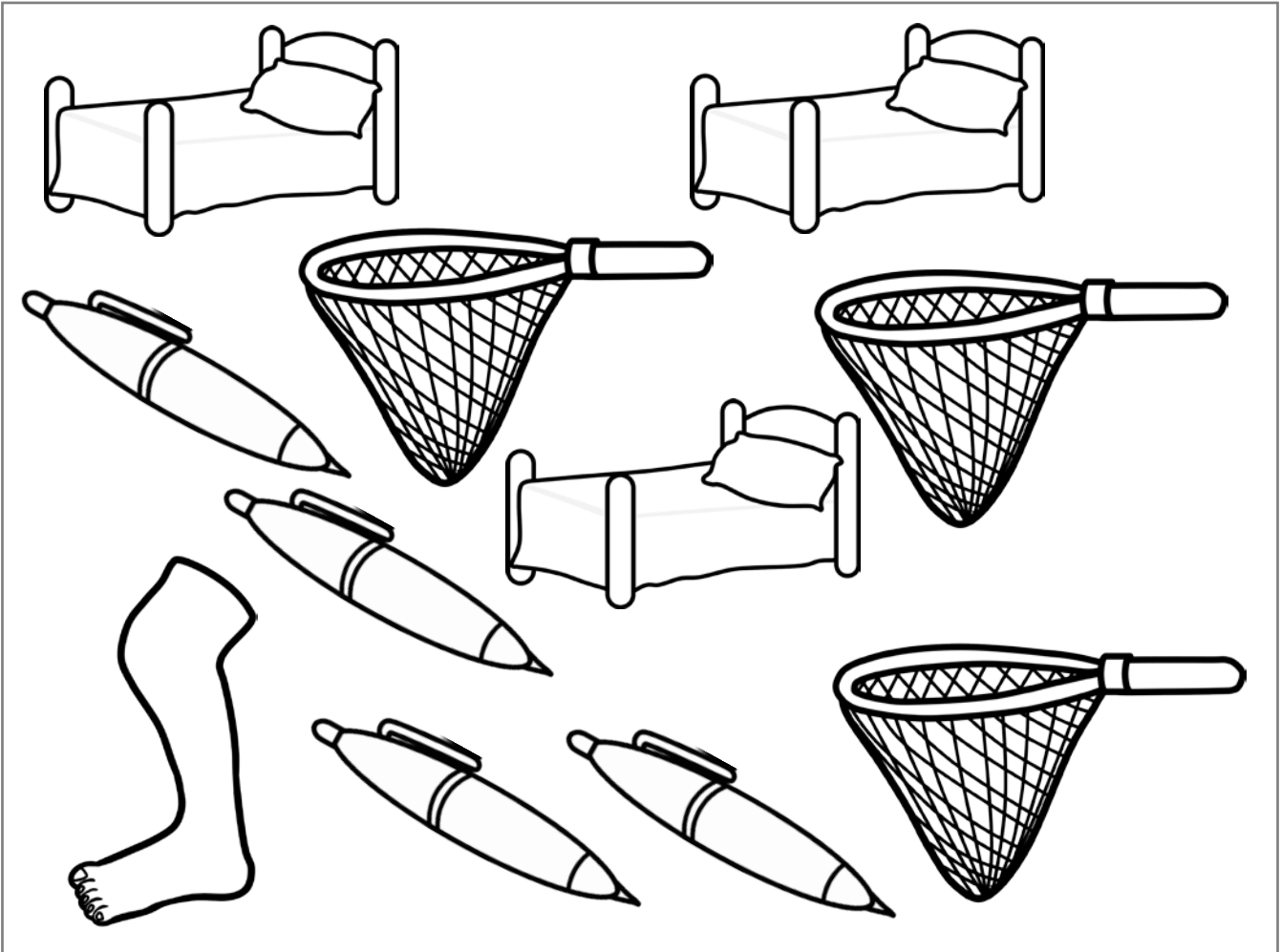
Directions: How many can you find?

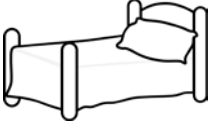
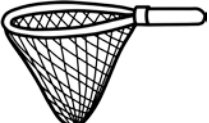

				
How many do you see?				
Write the word.				





Name: _____

CVC Words

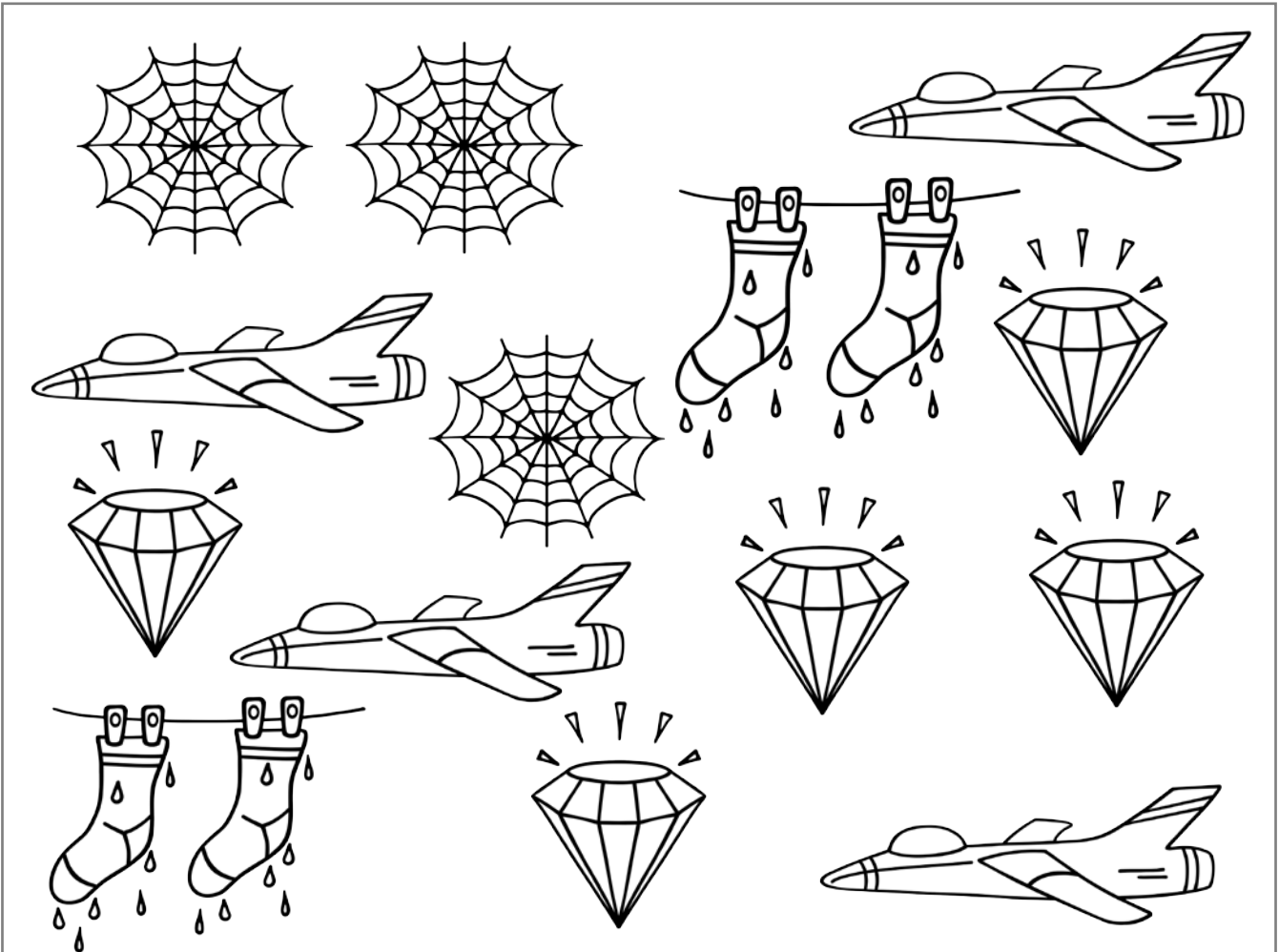
Hidden Pictures

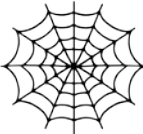
Directions: How many can you find?



				
How many do you see?				
Write the word.				





Name: _____

CVC Words

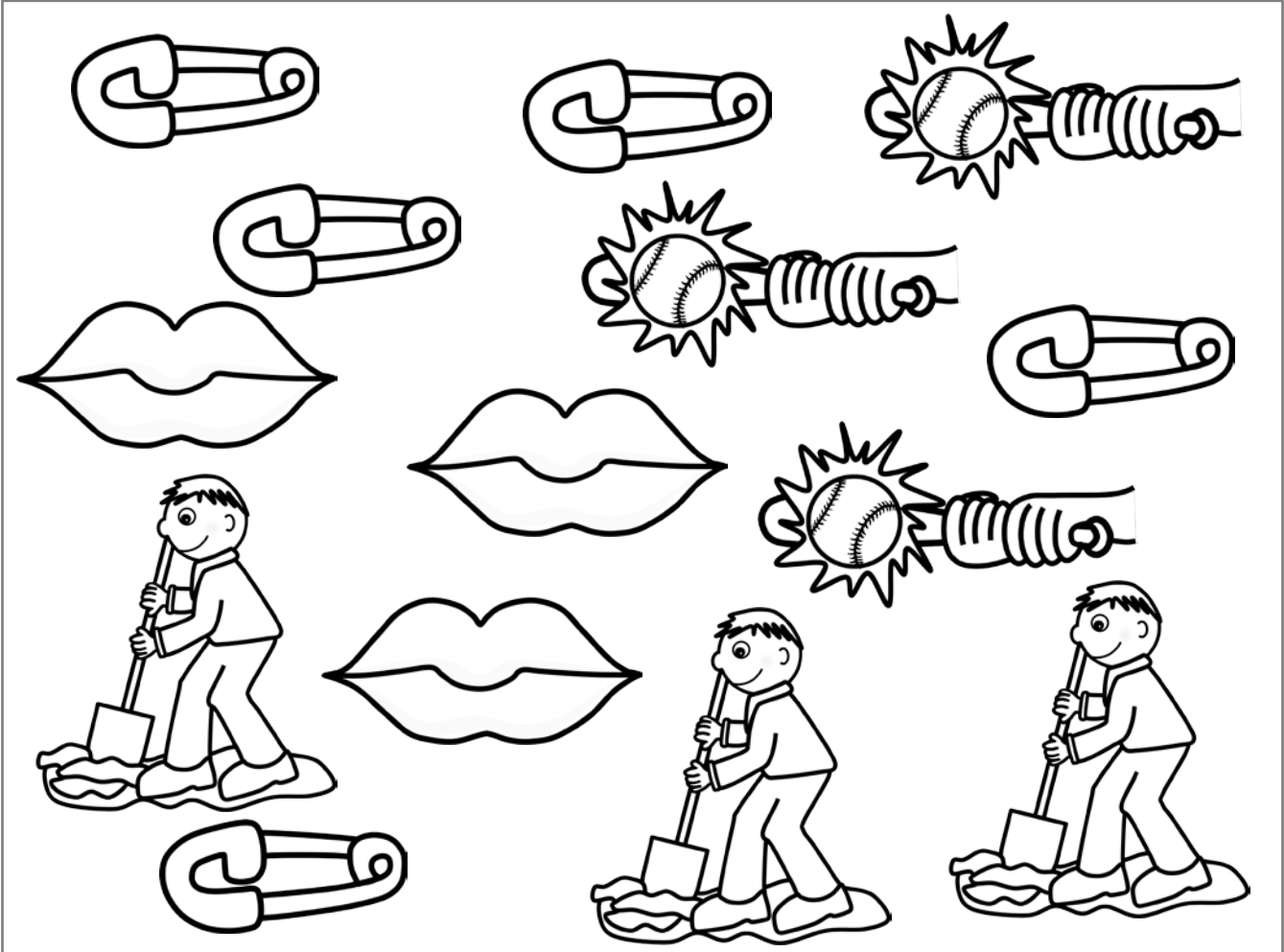
Hidden Pictures

Directions: How many can you find?

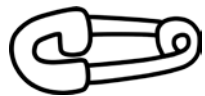

				
How many do you see?				
Write the word.				





Name: _____

CVC Words

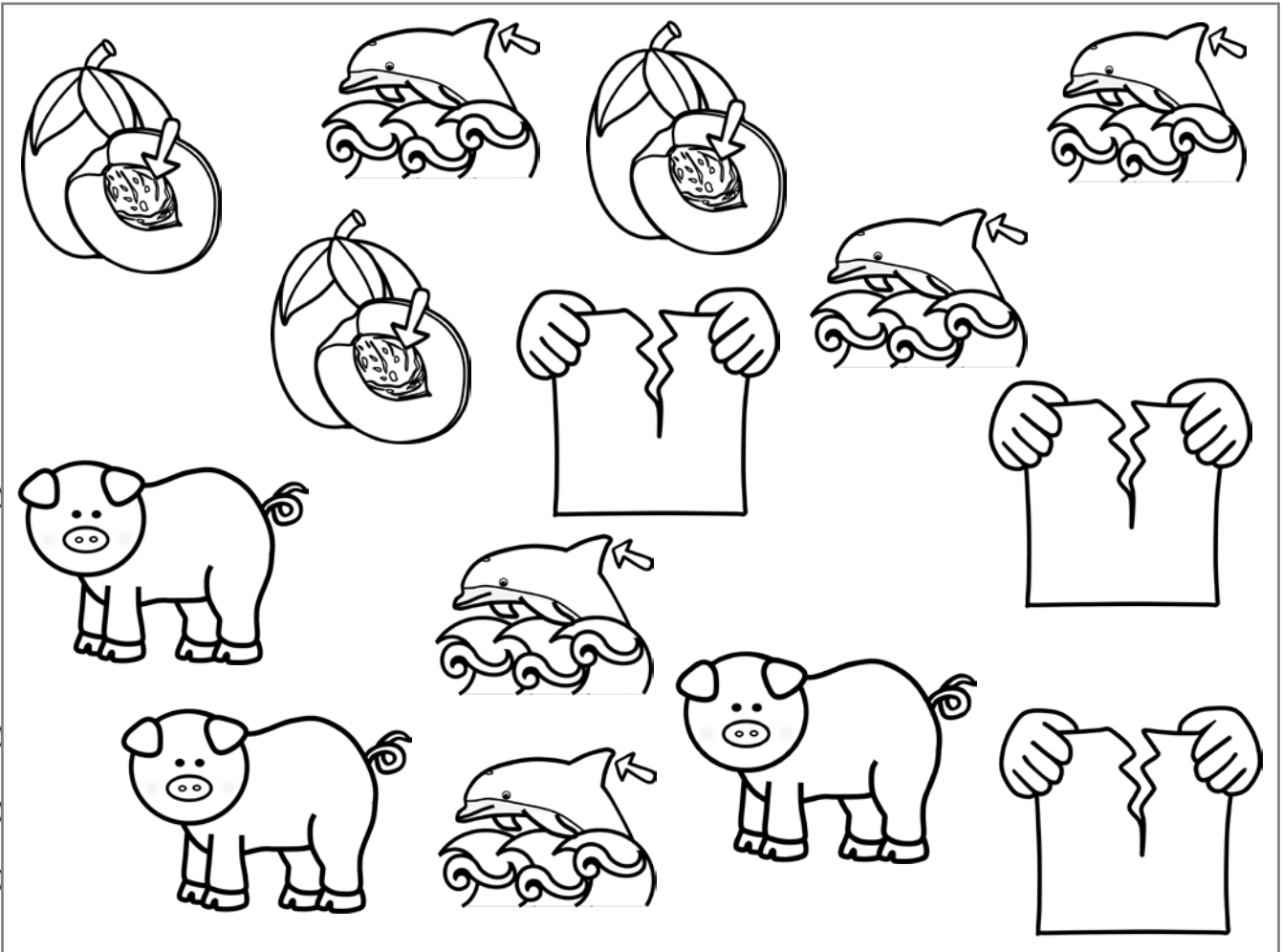
Hidden Pictures

Directions: How many can you find?

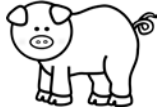

				
How many do you see?				
Write the word.				





Name: _____

CVC Words

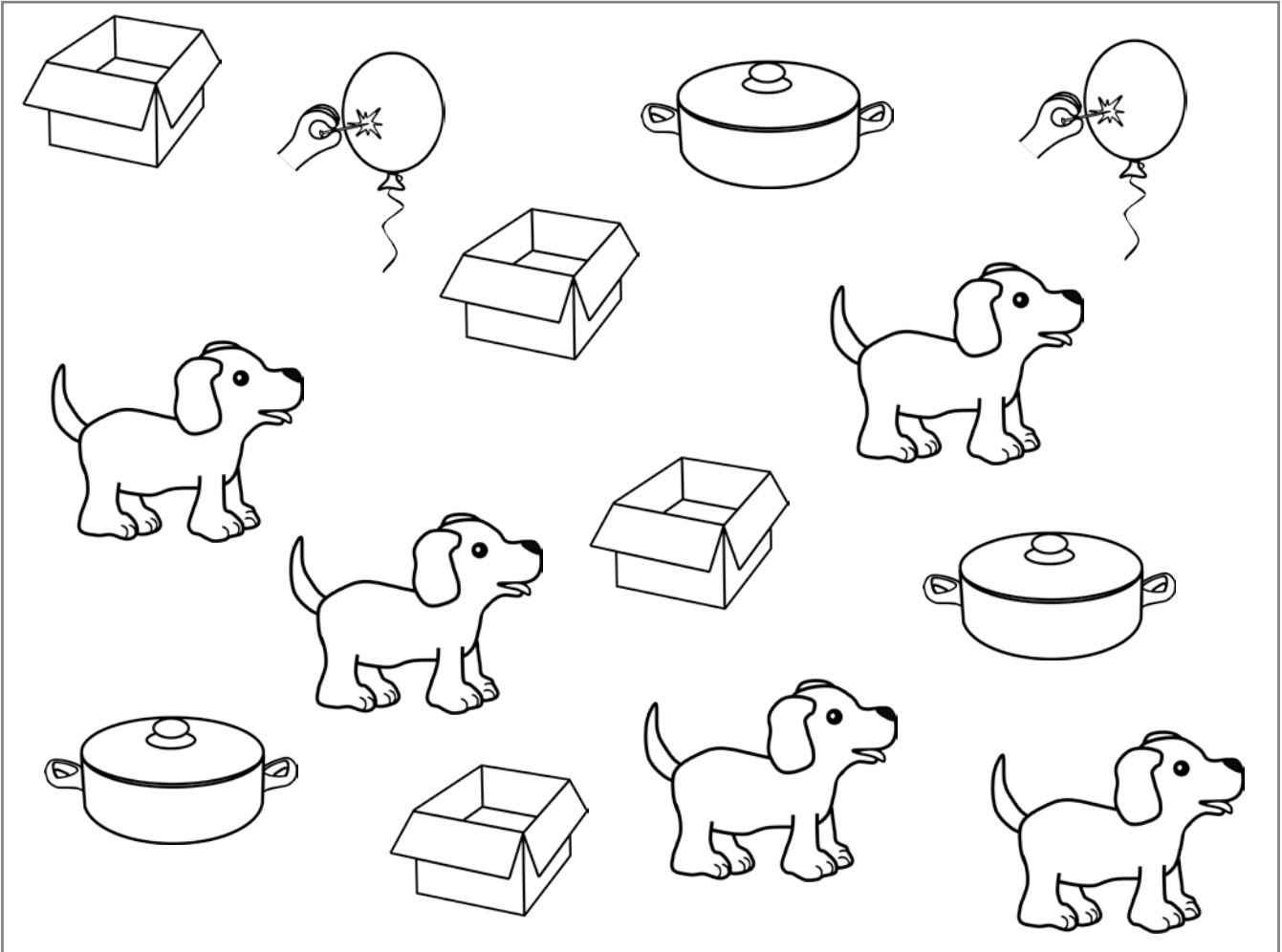
Hidden Pictures

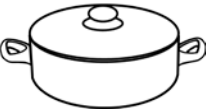
Directions: How many can you find?



				
How many do you see?				
Write the word.				





Name: _____

CVC Words

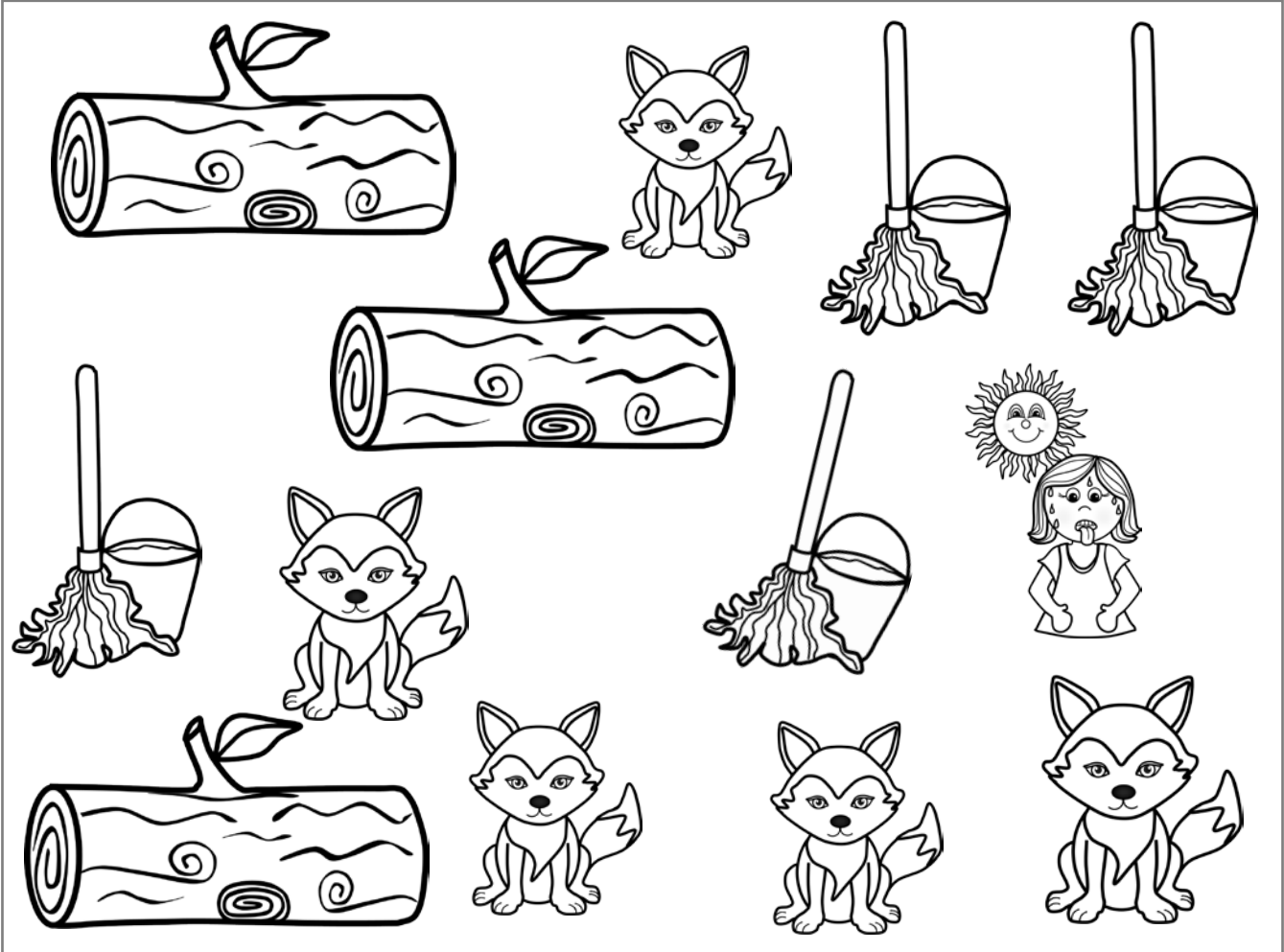
Hidden Pictures

Directions: How many can you find?



				
How many do you see?				
Write the word.				





Name: _____

CVC Words

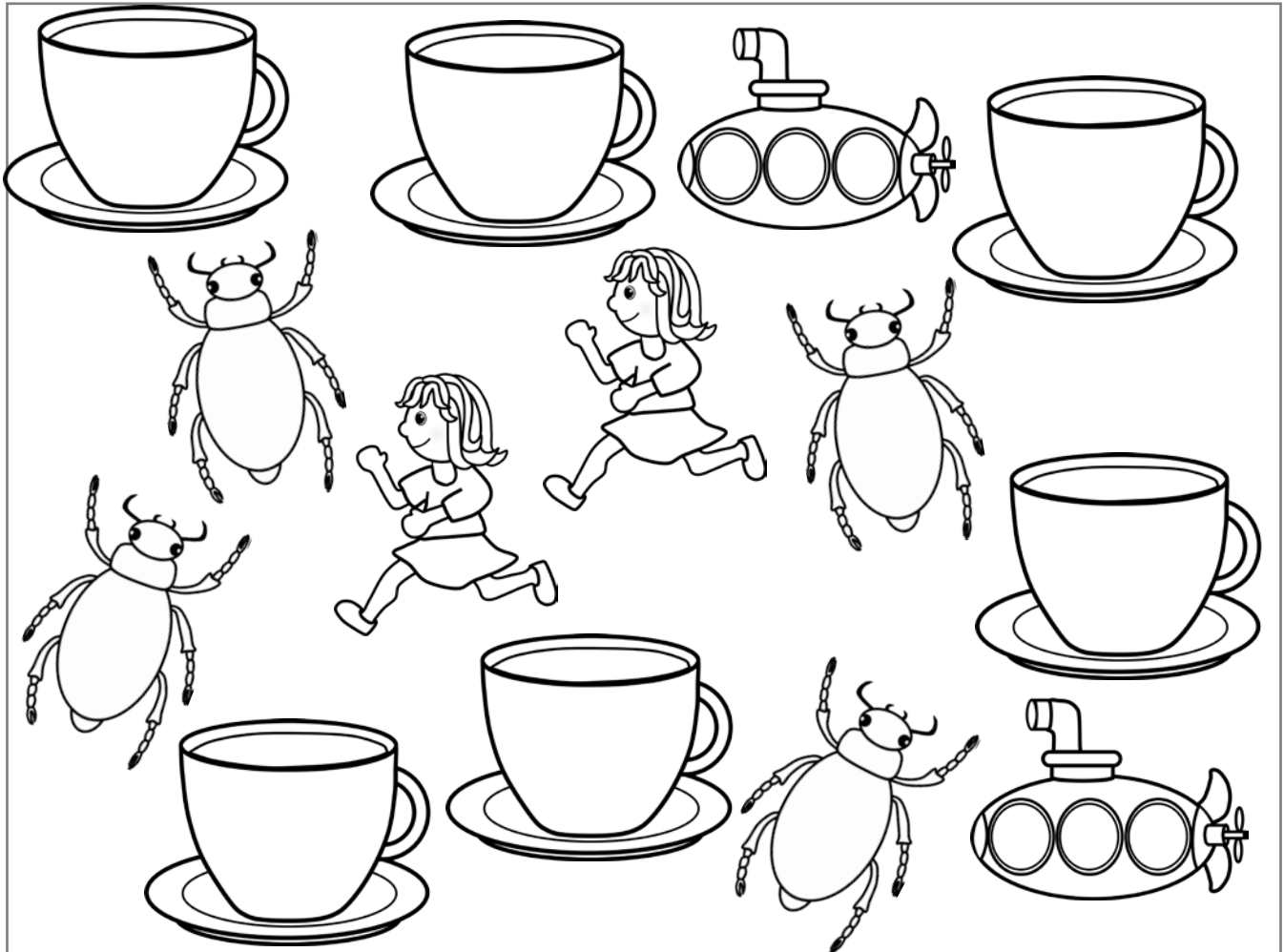
Hidden Pictures

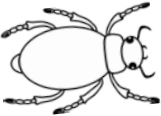
Directions: How many can you find?



				
How many do you see?				
Write the word.				

Name: _____

CVC Words

Hidden Pictures

Directions: How many can you find?

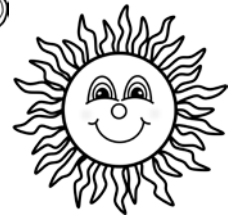

How many do you see?

Write the word.







Name: _____

CVC Words

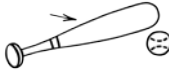
Hidden Pictures

Directions: How many can you find?



				
How many do you see?				
Write the word.				
				
How many do you see?				
Write the word.				







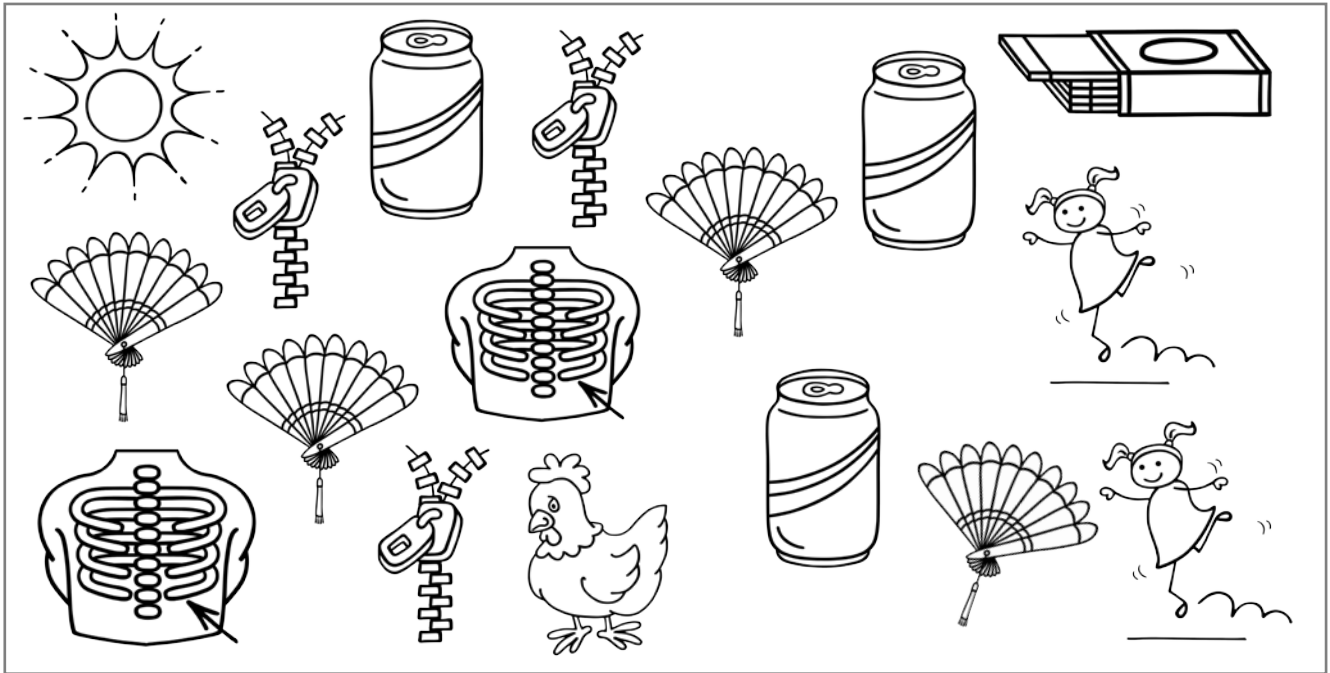

Name: _____

CVC Words

Hidden Pictures

Directions: How many can you find?



				
How many do you see?				
Write the word.				
				
How many do you see?				
Write the word.				